

Cosmetic Surgery

Product Catalog

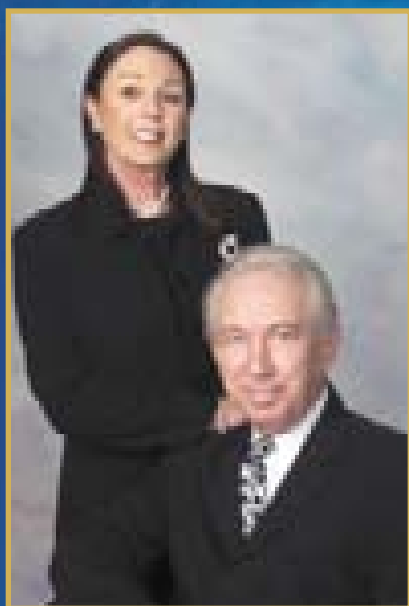

MABINA MEDICAL



*Marina and Anthony Zinnanti, Jr.
Founders*

A Message Our^{to} Customers



***A**s the growth of Marina Medical continues at a very exciting rate, we want to thank each of our customers for your continued loyalty and confidence in our product line. We have a deep gratitude to more than 5,000 offices in Plastic Surgery, Dermatology, and related disciplines who have become customers in the last five years.*

Since we attended our first clinical meeting in 1999 with the marketing philosophy of "The Doctor's Wholesaler", and offering excellent instruments at excellent prices, you have responded with your support and confidence in this program.

Now, we would like to do a little more for our loyal customers. Therefore, we are introducing the Marina Medical Preferred Customer Program. Through this program you are able to get additional rewards for the business that you continue to send to Marina Medical. The Preferred Customer Program is explained on page 2. Please take the time to acquaint yourself with it since you truly deserve our support as we have received yours.

Sincerely,

Marina C. Zinnanti
Anthony Zinnanti, Jr.

Marina C. Zinnanti

Anthony Zinnanti, Jr.



TABLE OF CONTENTS

Endoscopic	4-8	Ear, Nose & Throat	49-62
<i>Instruments for Forehead and Facelift Endoscopy</i>	4	<i>Nasal Series Specialty Retractors</i>	50
Telescope for Plastic Endoscopy	4	<i>Periosteal Elevators</i>	51
Endoscopic Sheaths	4	Ear Loops	52
Suction Coagulator	4	Curettes	52
<i>Instruments for Endoscopic Endobrow</i>	5	Mirrors & Accessories	53
Endoplastic Graspers & Scissors	5	<i>Nasal Rasps</i>	54-55
<i>Endo Dissectors</i>	6-7	<i>Chisels/Osteotomes</i>	56-57
<i>Endoscopic Retractors</i>	8-9	<i>Mallets</i>	58
<i>Endoscopic Equipment</i>	10	<i>Cartilage Crushers</i>	59
Scissors	11-23	<i>Rubin Rhinoplasty Set</i>	59-60
<i>General Series</i>	12	<i>Rongeurs & Bone Cutters</i>	61
Operating Scissors	12	<i>Truswell Trocar & Alligator/Cupped Forceps</i>	62
<i>Standard Iris Series</i>	13	Dermatology	63-68
<i>Dissecting Series</i>	14-15	<i>Biopsy Punches</i>	64
<i>Specialty Series</i>	16-17	<i>Bowls</i>	64
<i>Tenotomy Series</i>	18	<i>Dermal Curettes</i>	65
<i>Stitch Removal Series</i>	19	<i>Extractors</i>	66
<i>Nasal Series</i>	20-21	<i>Nail Nippers</i>	67
<i>Rhytidectomy Series</i>	22-23	<i>Scalpel Handles</i>	68
<i>Micro Series</i>	24	<i>Scalpels</i>	68
Forceps & Clamps	25-34	<i>Scalpel Remover</i>	68
<i>Dressing & Tissue Forceps</i>	26-27	Liposuction & Garments	69-74
<i>Bi-Polar Forceps</i>	28	<i>Cannulas & Tubing</i>	70
<i>Jeweler Series</i>	28	<i>Aspirators, Infusion & Tubing</i>	71
<i>Specialty Forceps</i>	29	<i>Garments for Liposuction</i>	72
<i>Micro Forceps</i>	29	<i>Binders</i>	73
<i>Splinter & Suture Removal Forceps</i>	30	<i>Compression Garments</i>	73
<i>Specialty Forceps</i>	31	<i>Surgical Bras</i>	74
<i>Hemostatic Clamps</i>	32	Surgical Accessories	75
<i>Hemostatic Forceps</i>	33	<i>Calipers</i>	76
<i>Towel Clips</i>	33-34	<i>Markers</i>	77
Needle Holders	35-38	<i>Laser Eyewear</i>	78-79
<i>Needle Holders</i>	36	<i>Ocuplasty</i>	79
<i>Micro Needle Holders</i>	38	<i>ESU</i>	80
Retractors & Skin Hooks	39-48	Smoke Evacuation Systems.....	80
<i>Breast Retractors & Dissectors</i>	40-41	Reusable Electrodes - Cutaneous Surgery	80
<i>Retractors</i>	42-43	Micro Dissection Needles	80
<i>Special Retractors</i>	44	<i>ULPA Filters, Tubing & Accessories</i>	81
<i>Tissue Wound Retractors</i>	45	<i>Cryosurgery</i>	82
Self-Retaining Skin Retractors	45	<i>Hair Restoration</i>	83
<i>Skin Hook Retractors</i>	46-47	<i>Sterilization & Infection Control</i>	84
<i>Rake Retractors</i>	48	<i>Sterilization Containers</i>	85
		<i>Fiberoptic Illumination Systems</i>	86
		<i>Instrumentation Sets</i>	87
		Index	88-89



The Value of the Preferred Customer Program



Join the Marina Medical

PREFERRED CUSTOMER CLUB

And start earning valuable rewards

Ask Your Account Manager Now

What is the Preferred Customer Program?

This is the **Marina Medical** way of saying "Thank You" to our customers. **Marina Medical** believes in sharing in its success and growth. Who better to share with than the customers that have helped us achieve our success. You do not have to do anything differently than what you are currently doing. By being a customer of **Marina Medical**, your account is automatically entered into the **Preferred Customer Program**. Obviously, the more you use **Marina Medical** products, the more Preferred Customer Reward Points will accumulate into your account. There is no extra cost or fee to you. It is simply a Thank You from **Marina Medical**.

How do you keep account of your points?

There are at least three ways for you to keep track of your Point Total. **Marina Medical** will send to you a quarterly update of your Point Total, along with announcements about the program. Your Point Total will also be on-line at www.marinamedical.com on any day that you access the **Marina Medical** website. You may also call **Marina Medical** Customer Service on any business day and ask for your Point Total.

What can you do with your points?

You may cash in your Preferred Customer Points for Preferred Customers Rewards including free instruments, instrument repair, discounts on future orders, or free services. A Rewards Chart may be requested from your **Marina Medical** Sales Rep. Watch for new Preferred Customer Rewards to be added to the Preferred Customer Program with each quarterly newsletter.

Warranty

Marina Medical stainless steel instruments are warranted for a period of two (2) years from the original date of purchase. **Marina Medical** single patient use products are warranted for 90 days against defects in workmanship or materials that are discovered prior to initial use or expiration. If **Marina Medical** instruments should fail as the result of a defect in materials or workmanship, **Marina Medical** is committed to take steps it believes are necessary to rectify the problem. These steps may include, but are not limited to, repair, replacement or supplying an alternative instrument. This warranty does not cover general maintenance such as cleaning and sharpening services required as a result of normal use. It does not include damage that is caused by misuse, improper care, the use of improper chemicals or cleaning methods, negligence, modification or unauthorized service by non-**Marina Medical** personnel, or normal wear. Damage to insulating coatings on electrosurgical instruments is excluded from the terms of this warranty.

The sole remedy under this warranty shall be repair or replacement as provided above at the sole discretion of **Marina Medical** Instruments. In no event will **Marina Medical** be liable for any damages arising out of loss of use, or any other incidental or consequential damages. The foregoing limited warranty is in lieu of any other warranty with respect to **Marina Medical** products. **Marina Medical** grants no other warranty, express or implied.

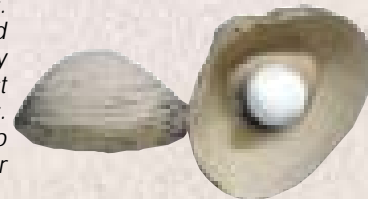

Returned Goods Policy

- Goods will be accepted for return for the following reasons and must be accompanied by a RGA.:
 - If shipment was made without Customer's authorization;
 - If incorrect items were shipped;
 - If defective items were shipped;
 - If defective goods are covered by the standard warranty;
 - If the goods were sent on evaluation basis.
- To return goods, contact a Customer Service Representative by telephone for an RGA (Returned Goods Authorization) number. The RGA # must also be clearly indicated on the outside of the returned package. Please have the following information:
 - Reason you wish to return the goods;
 - Quantity, description, product number;
 - Date of Receipt of Order;
 - Customer's Purchase Order and the Marina Medical invoice number;
 - All instruments that have been used must be cleaned and sterilized prior to shipment.
- Shipment must be returned prepaid by Customer. Freight collect shipments will not be accepted.
- If Customer intends to return equipment ordered in error, the following restocking charges and terms will apply:
 - 25% within 90 days from date of shipment;
 - Goods must be returned unused, in the original carton, and in marketable condition;
 - Refurbishing and replacement charges will be added to the restocking charges for damaged or missing items;
 - No return after 90 days;
 - No refund on sterile, single-use disposable products.
 - No refund will be made on customized instruments.

Send all Returns to:

Marina Medical
2761 North 29th Avenue
Hollywood, Florida 33020





ENDOSCOPIC

Instruments for Forehead and Facelift Endoscopy

Telescope for Plastic Endoscopy

Endoscope Sheaths

Endoscopic Graspers & Scissors

Endoscopic Dissectors

ENDOSCOPIC - *Instruments for Forehead and Facelift Endoscopy*

Telescope for Plastic Endoscopy

4mm diameter, 30° angle, 15cm/6.0in length, autoclavable

Product No.	Description	Product No.	Description
20-0174	New	20-0175	Refurbished
4mm diameter, 30° angle, 15cm/6.0in length, soakable			
Product No.	Description		
20-0180	Refurbished		



Other endoscope sizes available upon request.
 Storz™, Wolf™, ACMI™, compatible universal light adaptor. For use with endoscopic sheaths.

Endoscopic Sheaths



Storz™ compatible

Sheath with one rotating stop cock, spatula tip for the best view during tissue dissection.

Product No.
08-0170



Storz™ compatible

Sheath for plastic endoscopy with one rotating stop cock, with a flat spatula tip.

Product No.
08-0165



Suction Coagulator

Product No.	Description
08-0180	Spatula electrode, straight, with suction and stop cock
08-0182	Spatula electrode, curved, with suction and stop cock
08-0184	J-hook electrode, straight, with suction and stop cock
08-0186	J-hook electrode, curved, with suction and stop cock

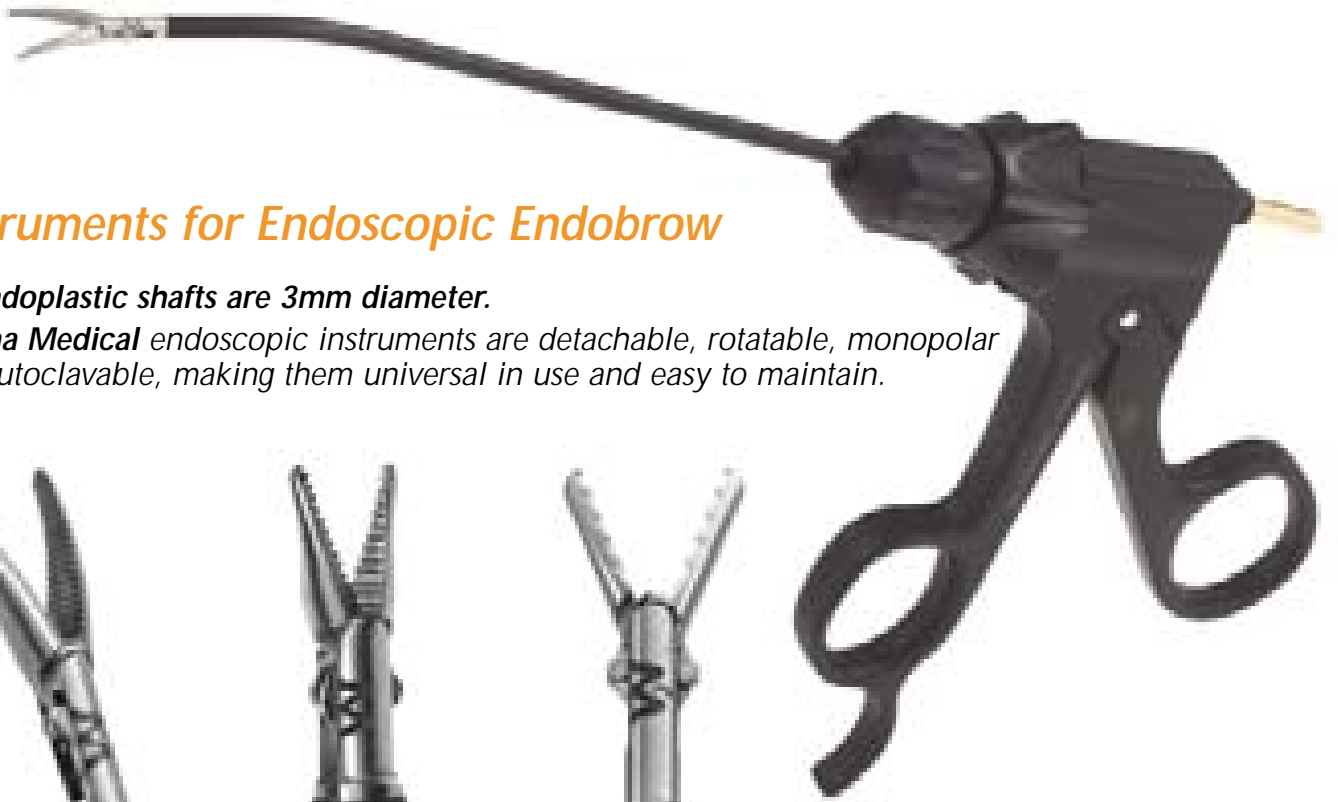

Instruments for Endoscopic Endobrow

All endoplastic shafts are 3mm diameter.

Marina Medical endoscopic instruments are detachable, rotatable, monopolar and autoclavable, making them universal in use and easy to maintain.



Curved Grasper
150-590

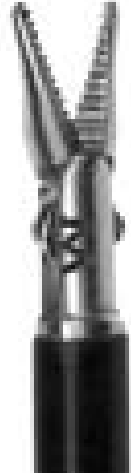

Needle Nose Grasper
150-586



Heavy Grasper
150-588

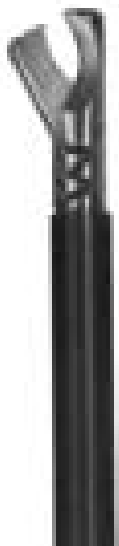

Micro Hook Scissors
150-552

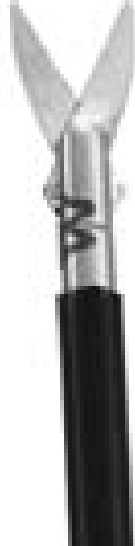

Micro Metzenbaum Scissors

Product No.	Description
150-548	Straight
150-550	Curved



**Custom
Instruments
available!**

ENDOSCOPIC

Marina Endo Dissectors

Designed to fit facial contours in endobrow and oculo-plastic procedures. A wide variety of styles available to accommodate different surgical procedures. Excellent balance, excellent grip.



Ergo Handle



For early dissection

Product No.

150-328

Slightly curved shaft, Langenbeck chisel tip, 7.0mm wide Length: 24.0cm/9.5in

150-327 - 5.0mm Tip

150-329 - 10.0mm Tip



For early dissection

Product No.

150-338

Straight shaft, slightly curved Langenbeck chisel tip, 7.0mm wide. Length: 22.5cm/8.75in

150-337 - 5.0mm Tip

150-339 - 10.0mm Tip

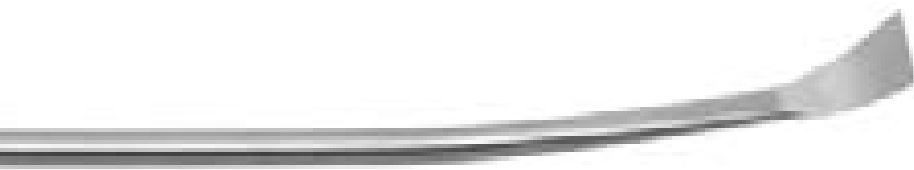

For broad quick scalp dissection

Product No.

150-322

Slightly curved shaft, tapered chisel tip, 30°, 12.5mm wide. Length: 24.0cm/9.5in



Curved with tapered tip for controlled dissection

Product No.

150-342

Curved shaft, cottle tip, 7.0mm wide. Length: 24.0cm/9.5in



Straight with tapered tip for controlled dissection

Product No.

150-341

Straight shaft, cottle tip, 7.0mm wide. Length: 24.0cm/9.5in



Periosteal dissector

Product No.

150-325

Curved shaft, wide, concave, shovel tip. Length: 25.0cm/10.0in



Small chisel head for orbital rim dissection

Product No.

150-323

Half curved shaft, mini-Langenbeck tip. Length: 24.0cm/9.5in

Product No.

150-340

Slightly curved shaft, tapered angled chisel tip,
12.5mm wide. Length: 23.0cm/9.0in

Scalp dissector

For Malleable instruments, add **M**
to the product number.

Product No.

150-332

S-shaped shaft, tapered and rounded tip,
10.0mm wide. Length: 24.0cm/9.5in

Mid face fascia dissector

Product No.

150-350

Endo Nerve Hook, curved, left.

Length: 24.0cm/9.5in

150-352

Curved right

Excellent for nerve retraction

Product No.

150-321

S-shaped shaft, round button finishing tip.

Length: 24.0cm/9.5in

Tip is bent up to accommodate delicate dissection sites

Product No.

150-324

S-shaped shaft, Langenbeck chisel tip, 7.0mm wide.

Length: 27.0cm/10.5in

Extends shaft for distant reach into periorbital areas

Product No.

150-336

Slightly curved shaft, mini-Cottle finishing tip,
4.0mm wide.

Length: 24.0cm/9.5in

Small cobra shaped head for nerve dissection

Product No.

150-326

Straight shaft, concave shovel tip.

Length: 24.0cm/9.5in

Temporal dissector

Product No.

150-344

Elevator with suction, round edges, slightly curved,
8.0mm wide

Length: 22.0cm/8.75in

Sharp edges for dissection with 2mm hole for aspiration



ENDOSCOPIC - *Marina Endoscopic Retractors*

To add **Fiberoptic Light**, add **L** to the product number.
 To add **Suction**, add **S** to the product number.
To add Fiberoptic Light and Suction, add **LS** to the product number.

To add **Endoscopic Sheath**, add **E** to the product number.
E requires 15cm length minimum blade and 15mm width minimum.

Each **Marina Medical Endo-Retractor** can be fitted with fiberoptic light and with suction. When intended for use with an endoscope, the Endo-Retractor will have the appropriate endoscope sheath mounted to it. **Marina Endo-Retractors** feature UNIVERSAL light cord adapters that are compatible to *Storz™, Wolf™, ACMI™, Olympus™* and most other fittings.



Tebbetts Style
 (with tooth serrated end)

Product No.
110-685S

Product No.	Blade Size (length x width)
110-690	80mm x 16mm
110-685	100mm x 25mm
110-686	120mm x 25mm
110-687	120mm x 30mm
110-688	150mm x 25mm
110-689	150mm x 30mm

Product shown is Tebbetts Style Retractor with Suction



Ferriera Style
 (with smooth end)

Product No.
110-676L

Product No.	Blade Size (length x width)
110-672	80mm x 16mm
110-675	100mm x 25mm
110-676	120mm x 25mm
110-677	120mm x 30mm
110-678	150mm x 25mm
110-679	150mm x 30mm

Product shown is Ferriera Style Retractor with Fiberoptic Light

Each Marina Medical Endo-Retractor blade can be customized to suit your personal preferences.

See pages 40-43 for additional Lighted Retractors.



Ferriera Style
(with smooth end)

Product No.
110-675LS

Product shown is
Ferriera Retractor with
Fiberoptic Light
and Suction

Fiberoptic Headlights

See page 86 for details.



Autoclavable Fiberoptic Cord

Product No.	Length
350-372	3 meters (10 ft.)

(ACMI™ Light Source End/
Storz™ Instrument End)



ENDOSCOPIC - *Marina Endoscopic Equipment*



Flat Screen Monitor

L200-5152-0

This monitor is specifically designed with the operating room in mind. This guarantees unique advantages for the surgeon and the surgical team. Alternative TV monitor also available.

Alternative Brand Refurbished: **20-2035**

Capture Device

L201-4650-A

Easy digital video recording on CD-Rom. Up to 80 minutes perfect digital video recording on CD-Rom. VCD, DVD and PC compatibility. Easy operation including remote control. Free software package including video editing and still image extraction.

Camera (TC804)

L201-2561-0

Top performance endoscopic 3-CCD camera with extremely light-weight and ergonomic camerahead. Magnetic ring-focus for both right-and left-handed operation. Two camera head buttons for remote control. High resolution and excellent light sensitivity. Adjustable triple field light level measurement. Easy "on the spot" cable replacement.

Alternative Brand Refurbished: **20-0200**

Light Source

L200-8282-0

XL300 top performance endoscopic 300 watt xenon lamp light source with microprocessor control and LCD display. Lamp-life LCD display and electronic lamp change indicator. Multi-standard exchangeable light cable sockets. Easy lamp replacement.

Alternative Brand Refurbished: **20-2020**

Light Source - 150 watts

250-803

Hallogen, 110 volts
(not shown)

Light Cable

Description	Product No.
ACMI to Storz™	350-372

ACMI light source end/Storz™ instrument end. Other connections available.

ACMI light source end/Storz™ instrument end. Other connections available.

*Marina Medical provides a number of options to meet your needs for endoscopic equipment. Whether you choose new or refurbished equipment, you will receive technical support, warranted equipment and the quality you have come to trust from **Marina Medical**.*

Cart

5 shelf, two drawer, easy to clean cart with locking wheels

Description	Product No.
Refurbished	20-2021
New	20-2025







SCISSORS

- Operating Scissors
- Dissecting Scissors
- Iris Scissors
- Specialty Scissors
- Stitch Removal Scissors
- Tenotomy Scissors
- Nasal Scissors
- Micro Scissors
- Rhytidectomy Scissors

MARINA MEDICAL SCISSORS - General Series

German Stainless Steel

 Stainless:	Highly corrosion-resistant German Stainless Steel is used in the manufacturing of each Marina scissors.
 Supercut:	One specially beveled blade gives the scissors additional guillotine cutting ability, while the other blade is serrated to hold the tissue. Excellent use when the tissue is denser.
 Tungsten Gold:	Special inserts of Tungsten Carbide line the edge of the blade. Tungsten Carbide is stronger than stainless steel and will keep a sharp cutting edge longer than regular stainless steel.
 Serrated:	For serrated blades. Add SR to any product number.

Standard Operating Scissors

Excellent for cutting suture, tissue, and other general uses in the OR or office



050-008

Sharp/Sharp

Length	Straight	Curved
11.5cm/4.5in	050-002	050-032
12.5cm/5.0in	050-004	050-034
15.0cm/6.0in	050-006	050-036
16.5cm/6.5in	050-008	050-038



 Add SR

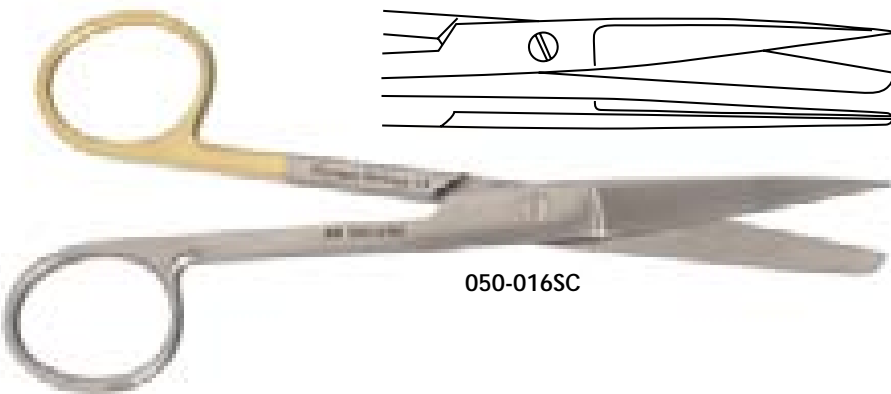

050-016SC

Sharp/Blunt

Length	Straight	Curved
11.5cm/4.5in	050-012	050-042
12.5cm/5.0in	050-014	050-044
14.5cm/5.75in	050-016	050-046
16.5cm/6.5in	050-018	050-048
18.5cm/7.25in	050-019	050-050



14.5cm/5.75in 050-016SC



 Add SR

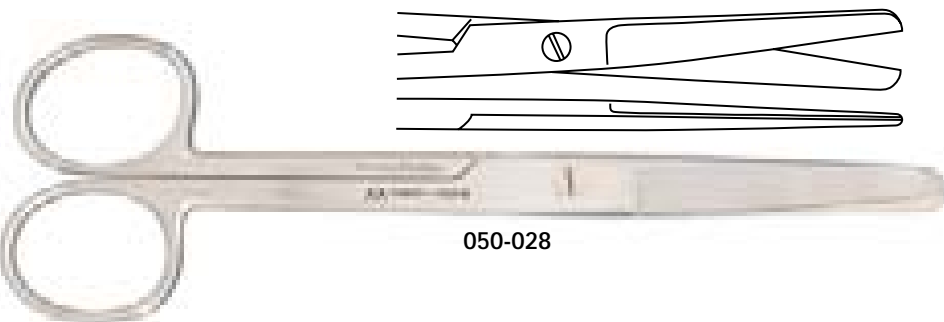

050-028

Blunt/Blunt

Length	Straight	Curved
12.5cm/5.0in	050-024	050-052
15.0cm/6.0in	050-026	050-056
16.5cm/6.5in	050-028	050-058



 Add SR

Standard Iris Scissors Series



400-912

Great for cutting tissue and general use

Iris

Length	Straight	Curved
9.0cm/3.5in, Extra fine	050-298 050-301	050-299 050-302
11.5cm/4.5in with serrated blade	050-304 050-305	050-306 050-307
11.5cm/4.5in	050-701SC	050-702SC
11.5cm/4.5in	400-912	400-913

 Add SR



Open Ring Iris

Length	Straight	Curved	
11.5cm/4.5in	050-309	050-310	Add SR

050-309

For those who prefer bigger finger rings

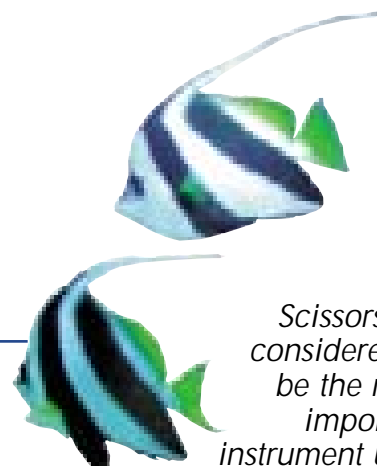

Scissors are considered to be the most important instrument used by a surgeon.

Marina Medical believes that it carries the finest scissors available at unmatched prices. We believe so much in our scissors that we guarantee them for life against manufacturing defects when used for their intended purpose.



Side Angled

Length	Straight
11.5cm/4.5in	050-308

Side angle provides more leverage

Add SR

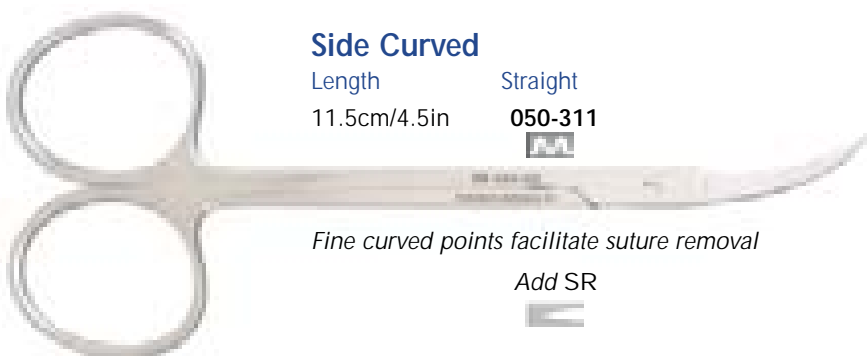

Side Curved

Length	Straight
11.5cm/4.5in	050-311

Fine curved points facilitate suture removal

Add SR

MARINA MEDICAL SCISSORS - *Dissecting Series*

German Stainless Steel

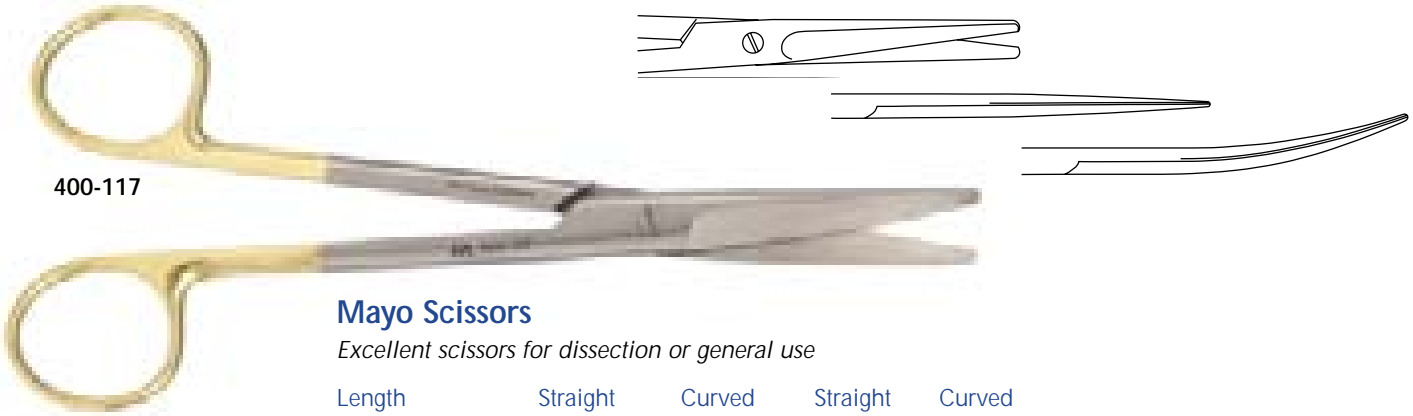

400-117

Mayo Scissors

Excellent scissors for dissection or general use

Length	Straight	Curved	Straight	Curved	
14.5cm / 5.75in	050-120	050-122	400-015	400-115	
17.0cm / 6.75in	050-124	050-126	400-017	400-117	
23.0cm / 9.0in	050-128	050-130	400-023	400-123	Add SR

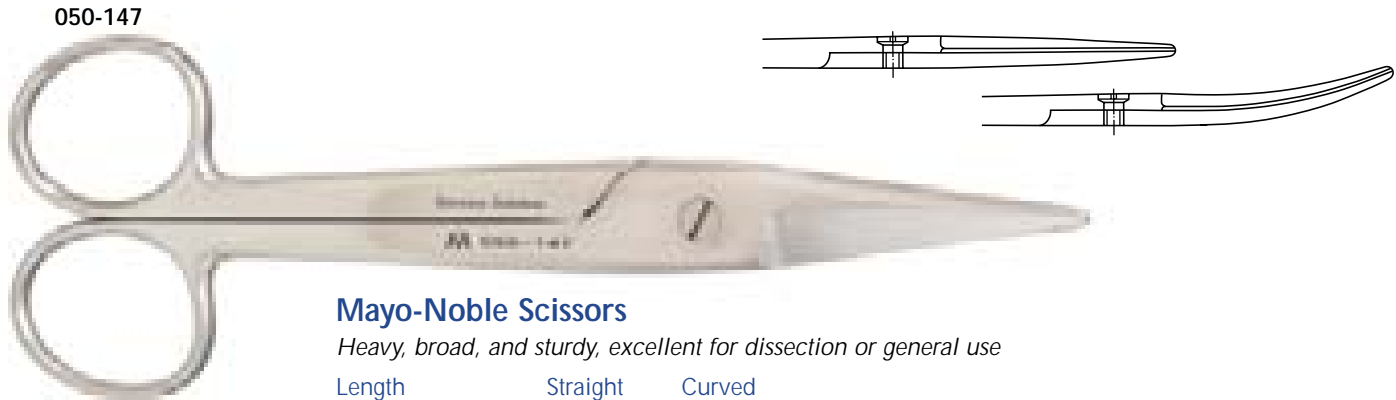

050-147

Mayo-Noble Scissors

Heavy, broad, and sturdy, excellent for dissection or general use

Length	Straight	Curved	
17.0cm / 6.75in	050-147	050-149	
19.5cm / 7.75in		050-145	Add SR

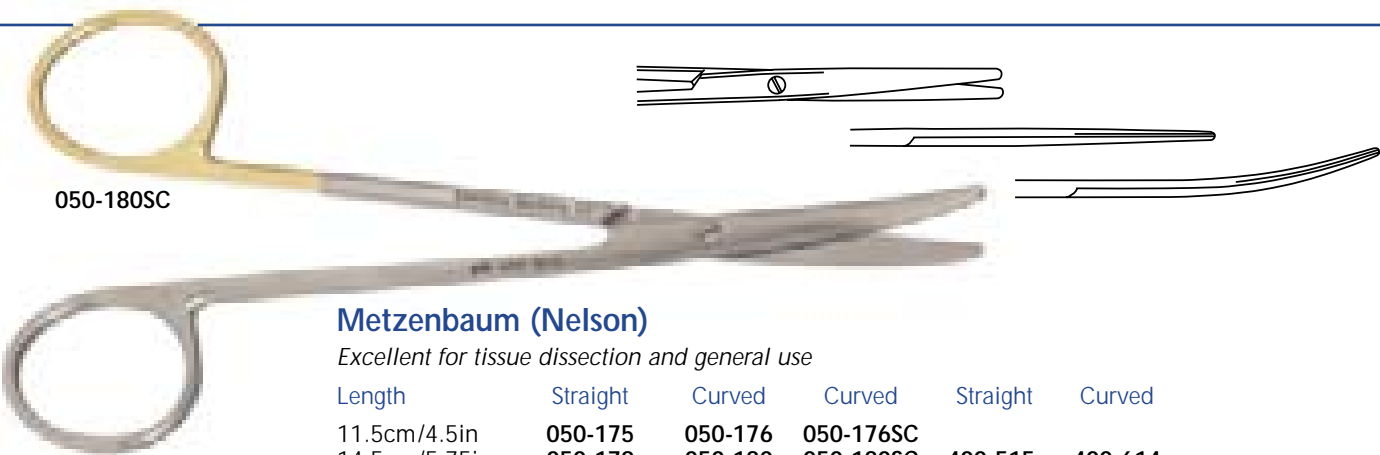

050-180SC

Metzenbaum (Nelson)

Excellent for tissue dissection and general use

Length	Straight	Curved	Curved	Straight	Curved	
11.5cm / 4.5in	050-175	050-176	050-176SC			
14.5cm / 5.75in	050-179	050-180	050-180SC	400-515	400-614	
18.0cm / 7.0in	050-181	050-182	050-182SC	400-518	400-618	
20.0cm / 8.0in	050-183	050-184	050-184SC	400-520	400-620	
23.0cm / 9.0in	050-186	050-188		400-523	400-623	
28.0cm / 11.0in	050-190	050-192		400-728	400-828	Add SR

Most **Marina Medical** scissors can be supplied in any variation of TC, SC, SS, and/or with serrations. The razor-sharp cutting edge of the Supercut scissors allow for smooth and effortless cutting through thick materials. The serrated cutting edge or the other cutting edge prevents the tissue from slipping. Supercut scissors are not suitable for wires, cartilage and other hard materials.

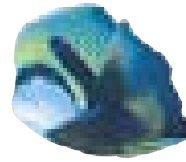

Categories





-  **Stainless**
-  **Supercut**
-  **Tungsten Gold**
-  **Serrated (add SR)**



400-923

Metzenbaum style scissors for cutting and tissue dissection

Strabismus



Length	Straight	Curved
11.5cm/4.5in	050-175	050-176
		
		050-176SC
		
10.0cm/4.0in	400-922	400-923
		
	Add SR	



050-316

Delicate shanks and short, rounded tips, very useful for undermining

Baby Lexer

Length	Curved
10.0cm/4.0in	050-316
	
	Add SR

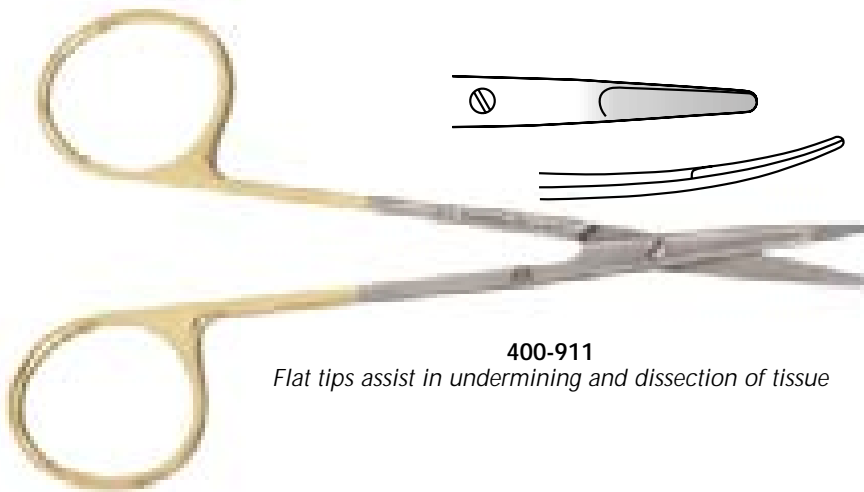

400-911

Flat tips assist in undermining and dissection of tissue

Ragnell (Kilner)

Length	Straight	Curved
12.0cm/4.75in	050-425	050-426
		
Length	Straight	Curved
12.0cm/4.75in		050-426SC
		
Length	Straight	Curved
12.0cm/4.75in	400-911	400-934
		
	Add SR	

MARINA MEDICAL SCISSORS - Specialty Series

German Stainless Steel

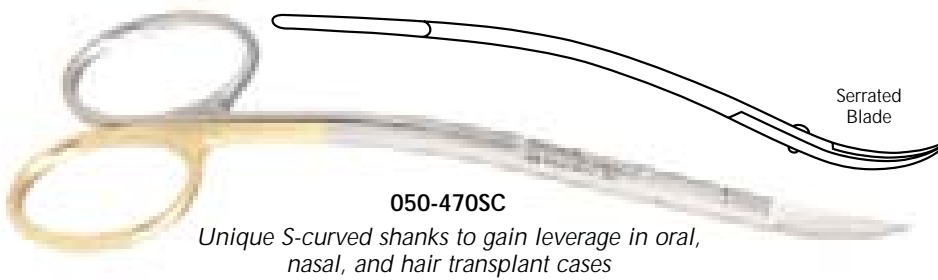

LaGrange S-Curved Shanks

Length
11.0cm/4.25in

Product No.
050-470

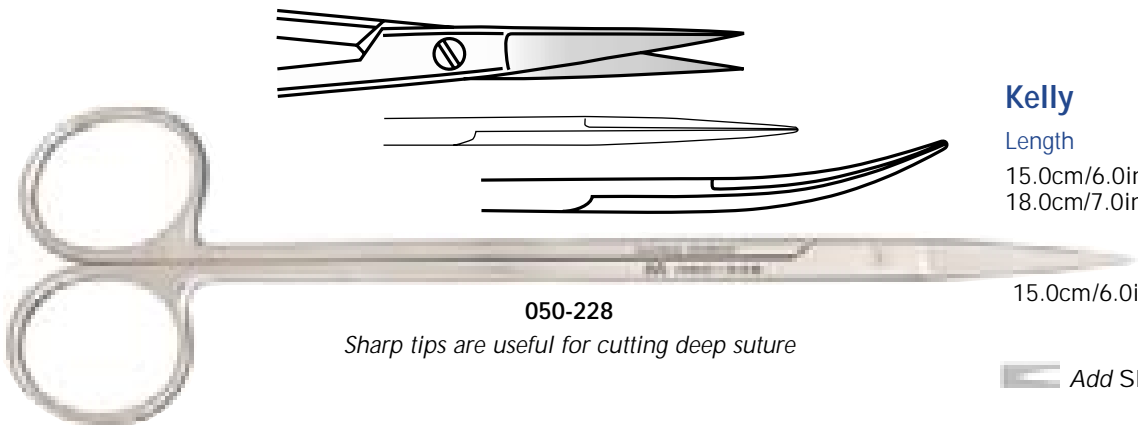

Kelly

Length
15.0cm/6.0in
18.0cm/7.0in

Straight
050-227
050-228

Curved
050-229
050-230

15.0cm/6.0in

400-940

400-941

Add SR



Littler

Length
11.5cm/4.5in, curved

Product No.
050-422

Add SR

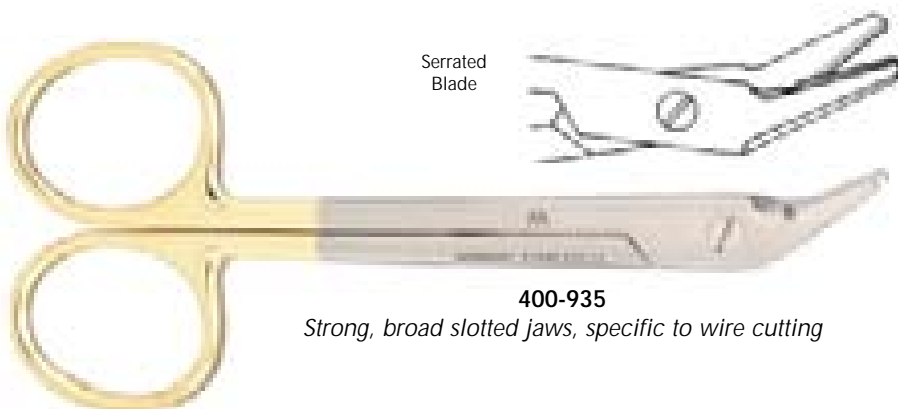

Wire Cutting

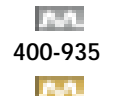

Length
12.0cm/4.75in

Product No.
050-260

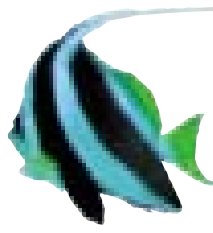



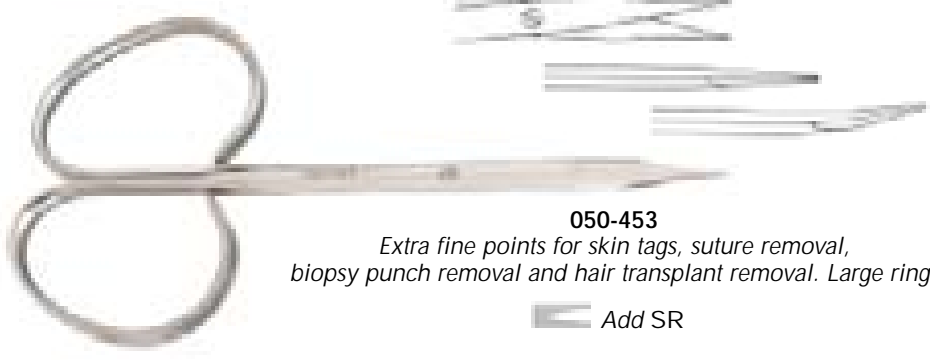

Categories

-  **Stainless**
-  **Supercut**
-  **Tungsten Gold**
-  **Serrated (add SR)**





050-453
Extra fine points for skin tags, suture removal, biopsy punch removal and hair transplant removal. Large rings

Open Ring Gradle

Length	Straight	Curved
10.0cm/4.0in	050-453	050-455
		

Closed Ring Gradle

Length	Straight	Curved
10.0cm/4.0in	050-453C	050-455C
		

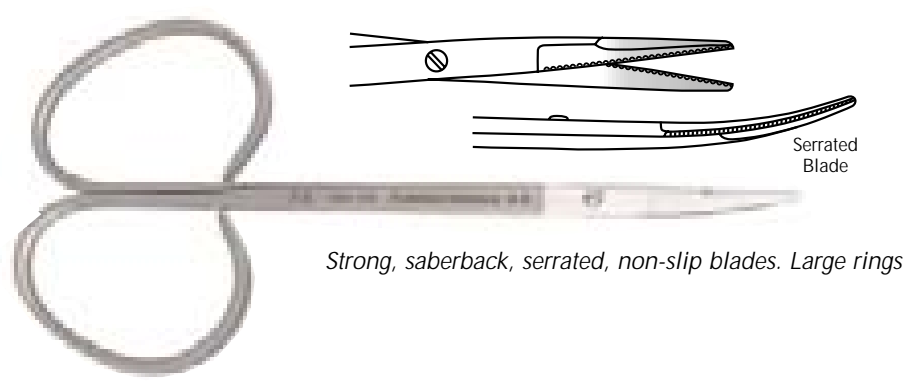

Strong, saberback, serrated, non-slip blades. Large rings

Open Ring Kaye Blepharoplasty

Length	Curved
10.5cm/4.25in	050-318
	



Delicate, flat-tipped, serrated blade

Marina Blepharoplasty

Length	Curved
13.5cm/5.25in	400-927
	



Great for cutting tough tissue, cartilage, and tissue dissection

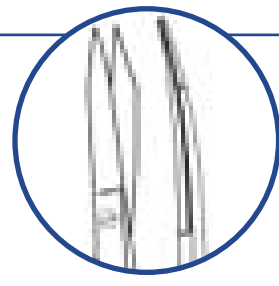

Martin Myomectomy

Description	Product No.
Straight, 20cm/8in.	050-532
Curved, 20cm/8in.	050-534
	





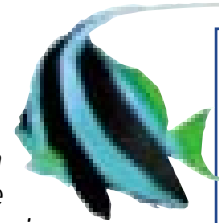

MARINA MEDICAL SCISSORS - Tenotomy Series

German Stainless Steel

Tungsten Carbide is one of the hardest alloys available and as a general rule, Tungsten Carbide instruments will last up to five times longer than stainless steel. **Marina Medical** offers Tungsten Carbide inlays that are soldered instead of welded, thus they are harder and will last longer than conventional Tungsten Carbide scissors.



Categories

-  **Stainless**
-  **Supercut**
-  **Tungsten Gold**
-  **Serrated (add SR)**

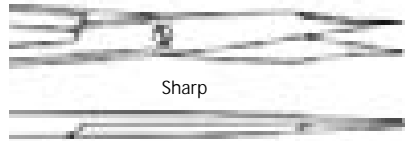

Stevens Series

Length	Description	Product No.
12.5cm/5.0in	B/B, Curved	050-402
11.0cm/4.25in	S/S, Curved	050-403
11.0cm/4.25in	B/B, Curved	050-404
11.0cm/4.25in	S/S, Straight	050-405
11.0cm/4.25in	B/B, Straight	050-406
11.0cm/4.25in	B/B, Straight	050-711SC
11.0cm/4.25in	B/B, Curved	050-712SC

 Add SR

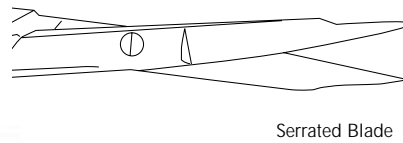

Goldman-Fox

Length	Straight	Curved
13.0cm/5.25in	050-451	050-452
13.0cm/5.25in		050-452SC

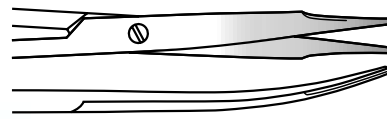
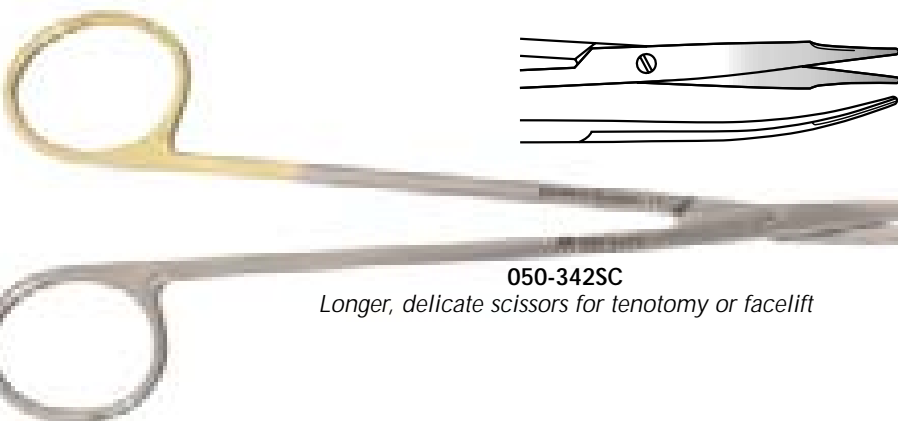

Reynolds

Length	Straight	Curved
15.0cm/6.0in	050-340	050-342
18.0cm/7.0in	050-344	050-346
18.0cm/7.0in		050-342SC

 Add SR

Stitch Removal Series

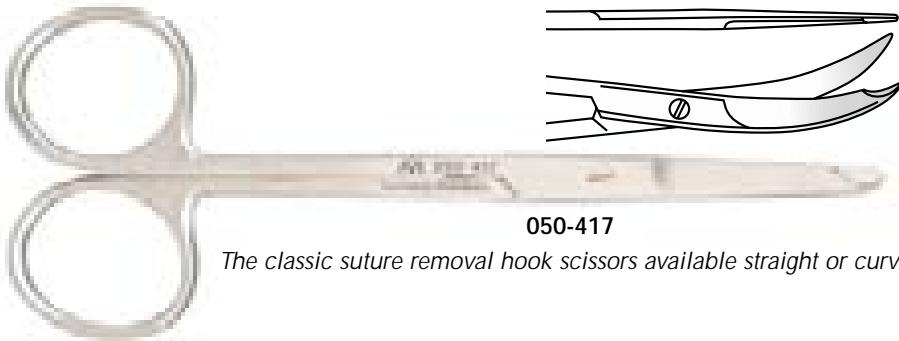

050-417

The classic suture removal hook scissors available straight or curved

Spencer Stitch Removal

Length	Straight	Curved
9.0cm / 3.5in	050-414	050-415
12.5cm / 5.0in	050-417	050-418



050-320

The newest suture removal scissors with fine angled 15mm blades

O'Brien Stitch Removal

Length	Product No.
10.0cm / 4.0in	050-320



050-419

Uniquely slender suture removal hook scissors

Littauer Stitch Removal

(more delicate)

Length	Product No.
14.0cm / 5.5in	050-419

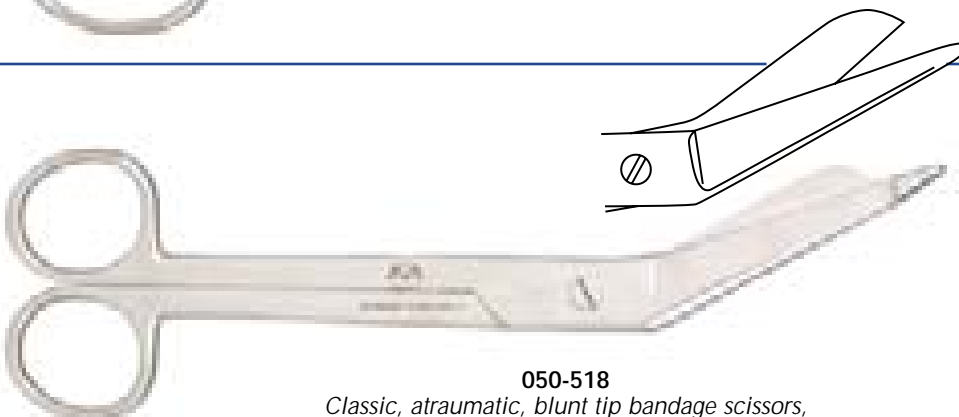

050-518

*Classic, atraumatic, blunt tip bandage scissors,
5 different lengths available*

Lister Bandage

Length	Product No.
9.0cm / 3.5in	050-510
11.5cm / 4.5in	050-512
14.0cm / 5.5in	050-514
18.0cm / 7.0in	050-516
20.0cm / 8.0in	050-518



Add SR



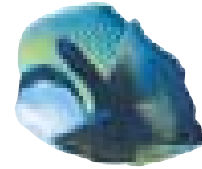

MARINA MEDICAL SCISSORS - Nasal Series

German Stainless Steel

Marina Medical can sharpen, tighten, or serrate any scissors for you. If you do not find what you are looking for in this catalog, please contact a customer service representative to assist you.



Categories

-  **Stainless**
-  **Supercut**
-  **Tungsten Gold**
-  **Serrated (add SR)**

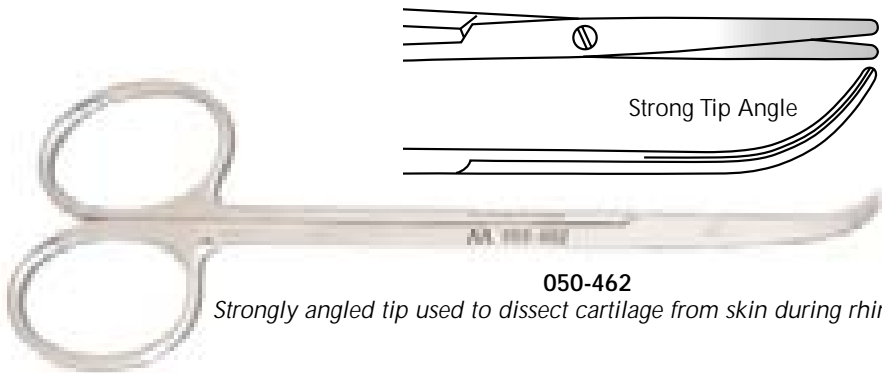

050-462
Strongly angled tip used to dissect cartilage from skin during rhinoplasty

Fomon Lower Lateral Alar

14.0cm/5.5in

050-462

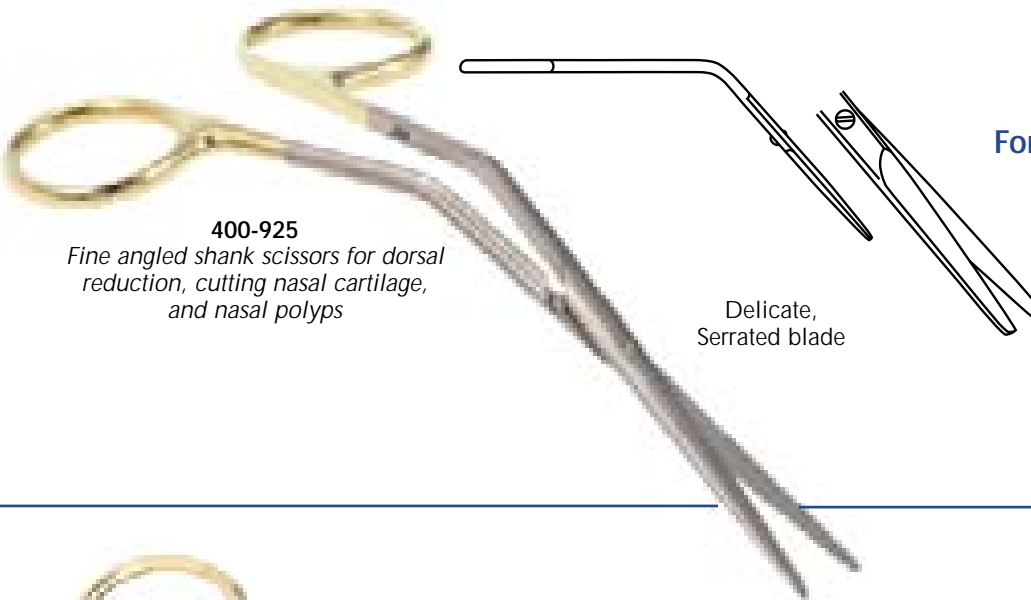

Add SR

400-925
Fine angled shank scissors for dorsal reduction, cutting nasal cartilage, and nasal polyps

Delicate, Serrated blade

Fomon Dorsal Angled Shanks

14.0cm/5.5in

050-460

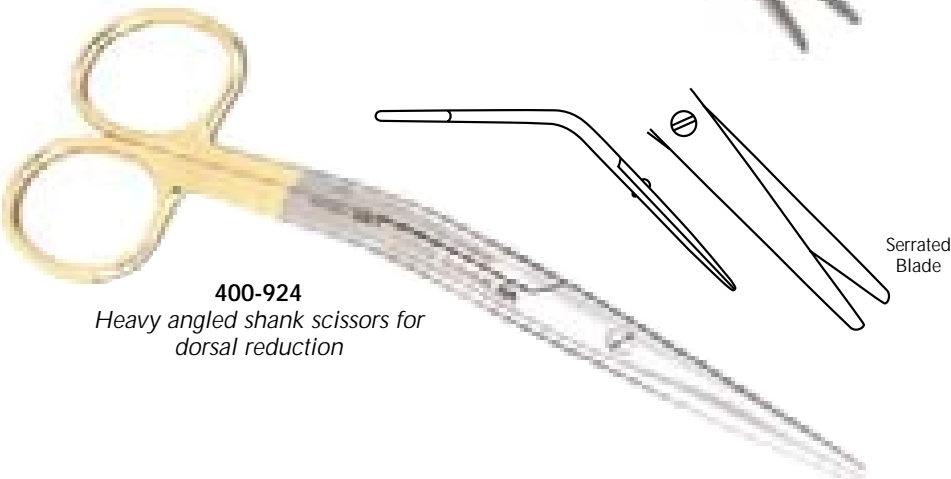

400-925

400-924
Heavy angled shank scissors for dorsal reduction

Serrated Blade

Cottle Dorsal Angled Shanks

16.0cm/6.25in

050-466



400-924



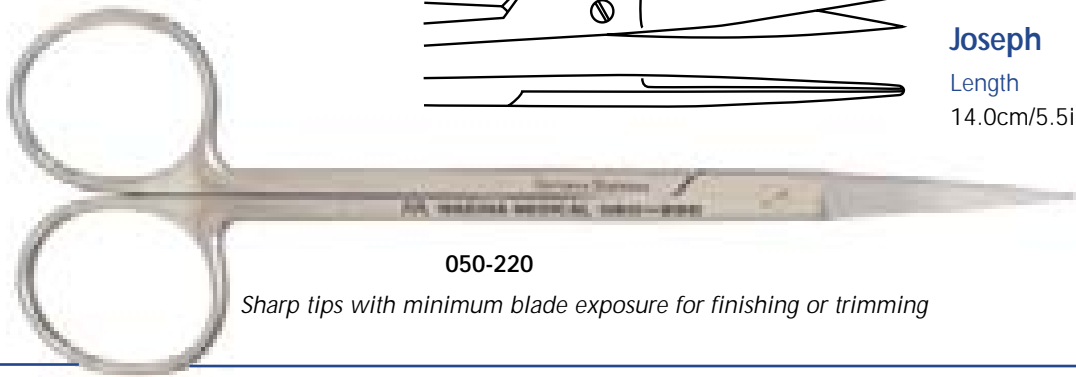

050-220

Sharp tips with minimum blade exposure for finishing or trimming

Joseph

Length
14.0cm/5.5in

Straight	Curved
050-220	050-221

Add SR

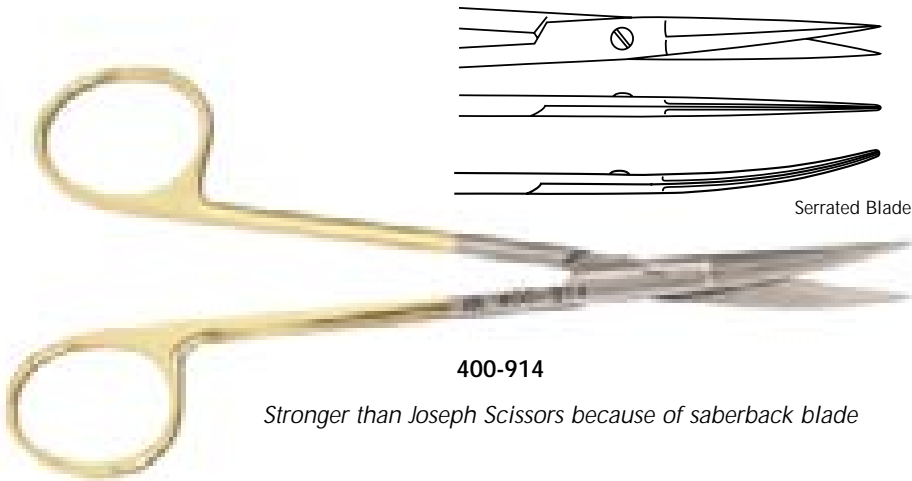

400-914

Stronger than Joseph Scissors because of saberback blade

Peck-Joseph

Length
14.0cm/5.5in

Straight	Curved
050-224	050-226

400-914

Serrated Blade

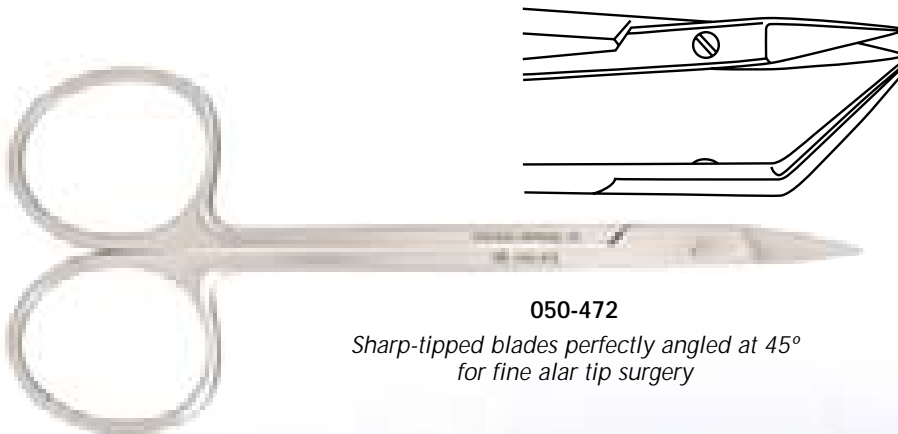

050-472

Sharp-tipped blades perfectly angled at 45° for fine alar tip surgery

Wilmer (Converse) Angled on Flat

Length Product No.
10.0cm/4.0in **050-472**

Add SR



MARINA MEDICAL SCISSORS - Rhytidectomy Scissors
 German Stainless Steel

Each Rhytidectomy Scissors comes with serrated blades.

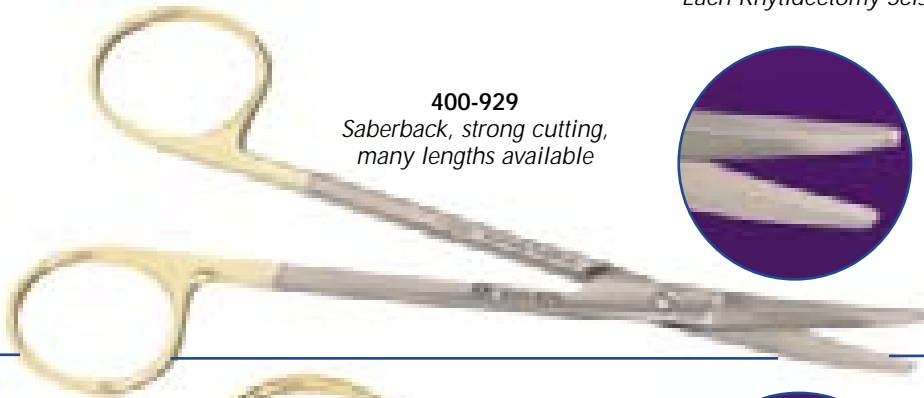

400-929
 Saberback, strong cutting,
 many lengths available

Kaye

Description

Curved, 11.5cm/4.5in
 Curved, 16.5cm/6.5in
 Curved, 14.0cm/5.5in

Product No.

400-928
400-929
400-932

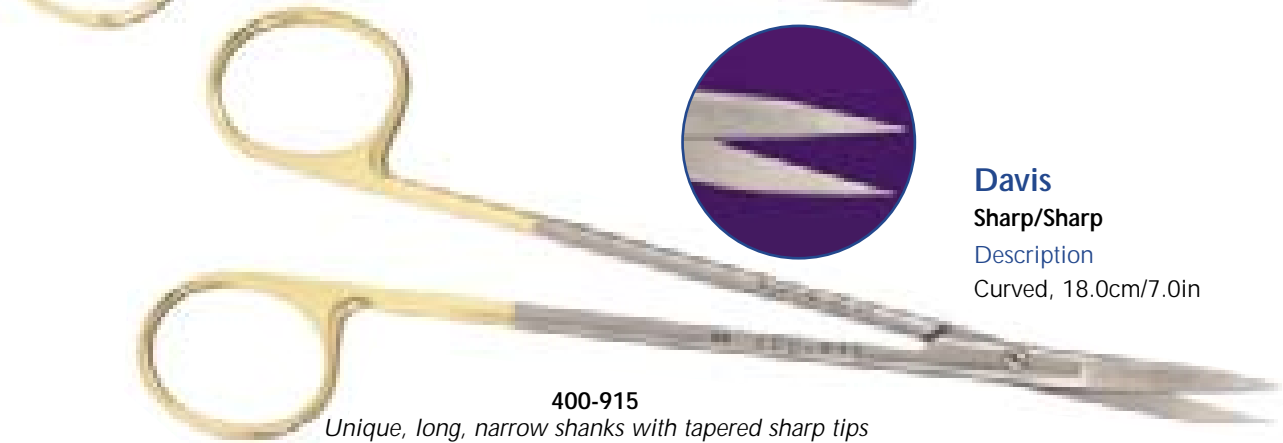

400-915
 Unique, long, narrow shanks with tapered sharp tips

Davis

Sharp/Sharp

Description

Curved, 18.0cm/7.0in

Product No.

400-915

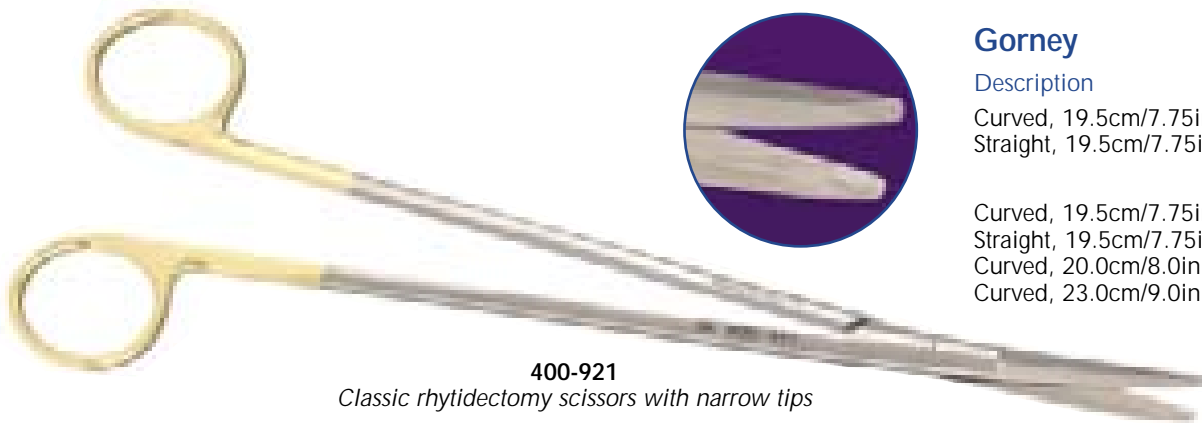

400-921
 Classic rhytidectomy scissors with narrow tips

Gorney

Description

Curved, 19.5cm/7.75in
 Straight, 19.5cm/7.75in

Product No.

050-473
050-474



Curved, 19.5cm/7.75in
 Straight, 19.5cm/7.75in
 Curved, 20.0cm/8.0in
 Curved, 23.0cm/9.0in

400-918
400-919
400-920
400-921

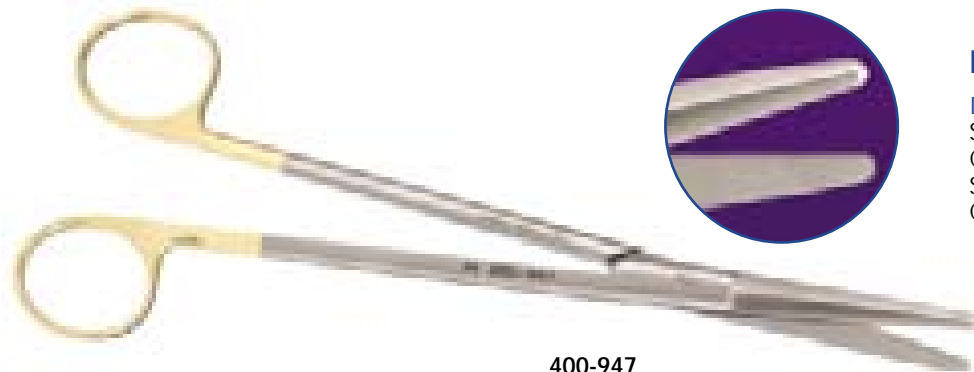

400-947
 Broader shanks for stronger cutting

Rees

Description

Straight, 16.5cm/6.5in
 Curved, 16.5cm/6.5in
 Straight, 20.0cm/8.0in
 Curved, 20.0cm/8.0in

Product No.

400-937
400-938
400-947
400-948



Marina Medical precise-cut Rhytidectomy scissors are offered in a wide selection of patterns. For use in various surgical procedures. Our precise-cut scissors are precision machined and handcrafted for longtime performance. Each scissors is finely balanced for accurate cutting and dissecting. Our guarantee to you is that each scissors will have excellent cutting action and long-lasting sharpness.

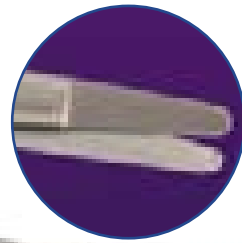
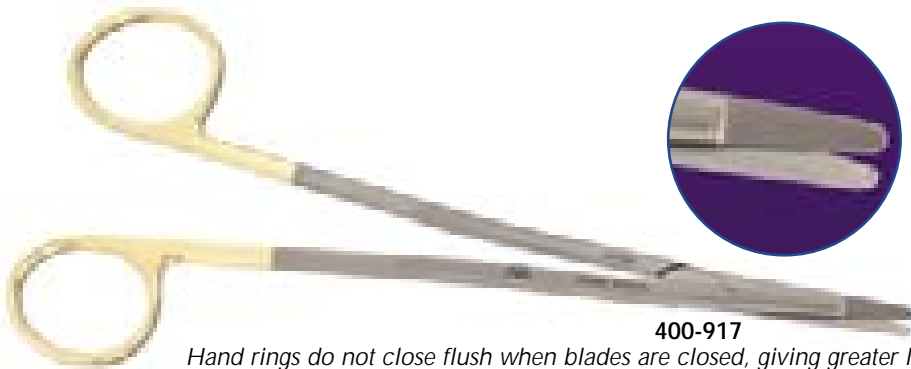
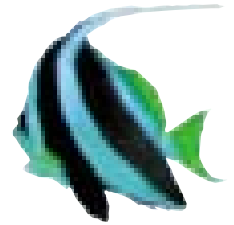

Freeman

Description

Curved, 17.5cm/6.75in

Straight, 18.0cm/7.0in
Curved, 18.0cm/7.0in

Product No.

050-467



400-916

400-917



400-917

Hand rings do not close flush when blades are closed, giving greater leverage and reducing fatigue

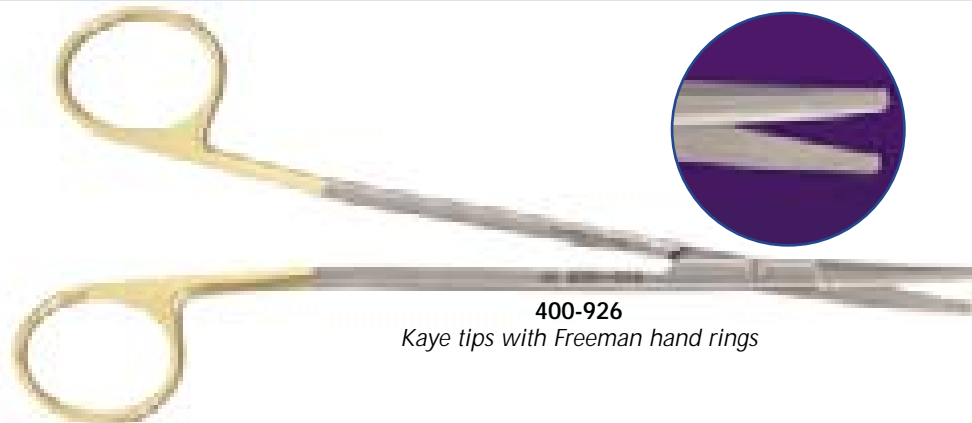

Freeman-Kaye

Description

Curved, 18.0cm/7.0in

Straight, 18.0cm/7.0in

Product No.

400-926

400-926S



400-926

Kaye tips with Freeman hand rings



Freeman-Gorney

Description

Straight, 19.0cm/7.5in

Curved, 19.0cm/7.5in

Product No.



400-950

400-952



400-952

Gorney tips with Freeman hand rings

Categories	
	Stainless
	Supercut
	Tungsten Gold
	Serrated (add SR)

MARINA MEDICAL SCISSORS - *Micro Scissors*

German Stainless Steel

Spring-action scissors provide greater control for microsurgery.

170-121

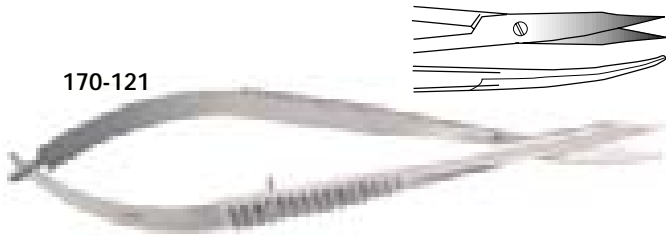

Durable, delicate blades for cutting tissue and suture

Westcott Utility

Description	Straight	Curved
10.0mm blades, 11.0cm/4.25in	170-121	170-122

 Add SR

170-124



Delicate blades for cutting delicate suture and tissue

Westcott Stitch

Description	Straight	Curved
Delicate blades, 12.0cm/4.75in	170-124	170-125

 Add SR

170-128

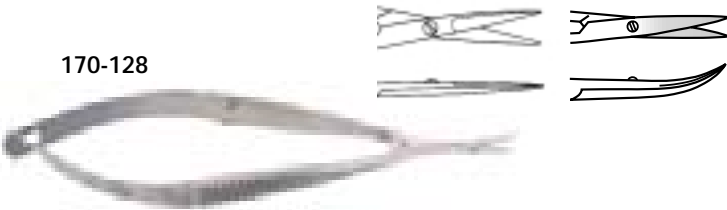

Cuts delicate eye tissue. Also used to cut fine suture

Vannas

Description	Straight	Curved
5.0mm blades, 7.5cm/3.0in	170-126	170-128

 Add SR

170-130

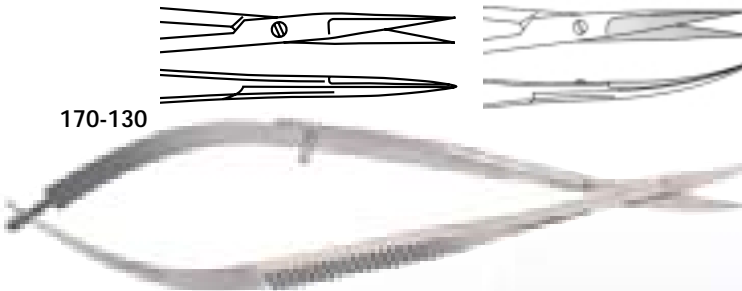

For conjunctival dissection

Castroviejo

Description	Curved S/S	Curved B/B
8.0mm blades, 10.0cm/4.0in	170-130	170-131

 Add SR



PREFERRED CUSTOMER CLUB

START EARNING YOUR VALUABLE POINTS TODAY!



Dressing & Tissue Forceps

Jeweler Forceps

Specialty Forceps

Suture Removal Forceps

Hemostatic Clamps

Towel Clips

The background of the page is a photograph of two yellow and black striped fish swimming in clear blue water. The fish are positioned in the lower-left and lower-right areas of the frame. The water is bright and clear, with some light rays visible. The overall color palette is dominated by blues and greens, with the yellow and black stripes of the fish providing a focal point.

FORCEPS & CLAMPS

FORCEPS & CLAMPS - Dressing & Tissue Forceps



Dressing Forceps

No teeth, serrations

Product No.	Length
060-004	11.5cm/4.5in
060-005	11.5cm/4.5in, Curved
060-006	12.5cm/5.0in
060-008	14.5cm/5.75in
060-010	16.0cm/6.25in
060-012	18.5cm/7.25in
060-014	20.0cm/8.0in
060-016	25.5cm/10.0in
060-018	30.0cm/11.75in



Tissue (Pick-up) Forceps

1 x 2 teeth, no serrations

Product No.	Length
060-040	11.5cm/4.5in
060-042	12.5cm/5.0in
060-044	14.5cm/5.75in
060-046	16.0cm/6.25in
060-047	17.5cm/7.0in
060-048	20.0cm/8.0in
060-050	25.5cm/10.0in
060-053	30.5cm/12.0in



Semken Forceps

Very delicate tip, 1.0mm

No teeth

Product No.	Length
060-058	15.0cm/6.0in

1 x 2 teeth

Product No.	Length
060-060	15.0cm/6.0in

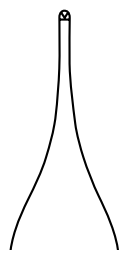

Adson Tissue

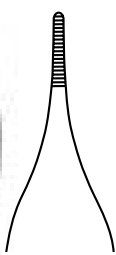
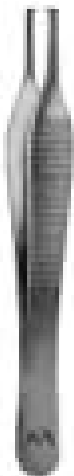

Adson Dressing

Adson Forceps

Without teeth, serrated tips

Product No.	Description - Length
060-117	Delicate, Straight - 1.5mm tip - 12.0cm/4.75in
060-120	Straight - 2.0mm tip - 12.0cm/4.75in
060-121	Fenestrated Handle, 2mm tip - 12.0cm/4.75in
060-125	Straight, 2.0mm tip - 15.0cm/6.0in

With teeth

Product No.	Description - Length
060-130	1 x 2, Smooth, 2.0mm tip, Straight - 12.0cm/4.75in
060-131	1 x 2, Fenestrated Handle, Straight - 2.0mm tip - 12.0cm/4.75in
060-132	1 x 2, Straight - 2.0mm tip - 15.0cm/6.0in
060-134	1 x 2, Delicate, 1.5mm tip, Straight - 12.0cm/4.75in
060-140	1 x 2, Smooth, 2.0mm tip, Curved - 12.0cm/4.75in
060-150	2 x 3, Smooth, 3.0mm, Straight - 12.0cm/4.75in,

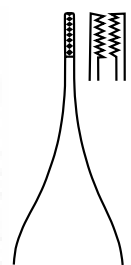
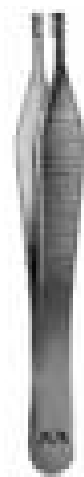

Adson-Brown Forceps

7 x 7 Teeth, 2.0mm tip

Product No.	Description - Length
060-170	Standard - 12.0cm/4.75in
060-171	Fenestrated Handle - 12.0cm/4.75in
060-174	Standard - 15.0cm/6.0in
060-172	Angled - 12.0cm/4.75in

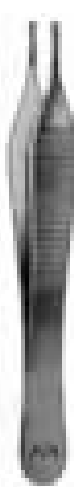

Adson Dressing

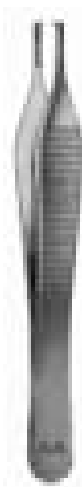

Adson Tissue

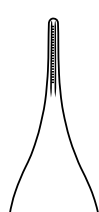
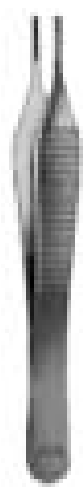

Adson DeBakey

Adson Forceps w/ Tying Platform

Without teeth

Product No.	Description - Length
060-126	Standard 2.0mm tip, Serrated - 12.0cm/4.75in
060-128	Delicate, 1.5mm tip, Serrated - 12.0cm/4.75in

With teeth

Product No.	Description - Length
060-136	1 x 2 Teeth, Smooth, 2.0mm tip - 12.0cm/4.75in
060-137	1 x 2 Teeth, Serrated, 2.0mm tip - 12.0cm/4.75in
060-138	1 x 2 Teeth, Serrated, Delicate, 1.5mm tip - 12.0cm/4.75in
060-160	Adson w/ DeBakey Teeth - 12.0cm/4.75in, atraumatic, 2.0mm jaw

Marina Medical will coat any forceps with long-lasting non-conductive nylon coating. Please add NC after the product number for your non-conductive instrument.



440-212

Adson Forceps

Tungsten Carbide

Product No.	Description - Length
440-212	Smooth Platform, TC tips, No Teeth - 12.0cm/4.75in
440-214	Delicate Serrated Platform, TC tips, No Teeth - 12.0cm/4.75in
440-312	Serrated Platform, 1 x 2 Teeth, TC tips -12.0cm/4.75in
440-315	Delicate, Serrated Platform, TC tips, No Teeth - 15.0cm/6.0in
440-316	1 x 2 Teeth, Delicate Serrated Platform, TC tips - 12.0cm/4.75in
440-317	1 x 2 Teeth, Delicate Serrated Platform, TC tips - 15.0cm/6.0in

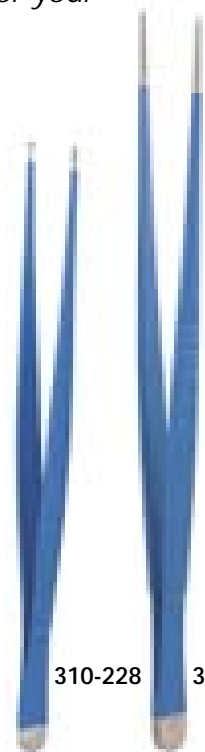

310-228

330-218

Non-conductive

Potts-Smith Forceps

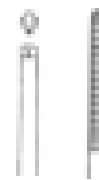

Dressing (No teeth), 2.0mm Jaw

with Non-conductive Coating

Product No.	Product No.	Length
060-218	310-218	18.0cm/7.0in
060-221	310-221	21.0cm/8.25in
060-224	310-224	24.0cm/9.5in

Tissue, 1 x 2 Teeth, 2.0mm Jaw

Product No.	Product No.	Length
060-228	310-228	18.0cm/7.0in
060-231	310-231	21.0cm/8.25in
060-234	310-234	24.0cm/9.5in

Iris (Graefe) Forceps



Add NC for non-conductive coating

Serrated, no teeth

Length

10.0cm/4.0in (Iris)

7.0cm/2.75in (Graefe)

Product No. 060-400	Product No. 060-402	Product No. 060-404
Product No. 060-406	Product No. 060-408	

1 x 2 teeth

Length

10.0cm/4.0in (Iris)

7.0cm/2.75in (Graefe)

Product No. 060-410	Product No. 060-411	Product No. 060-412
Product No. 060-414	Product No. 060-416	

DeBakey Tissue Forceps



Add NC for non-conductive coating

1.5mm	2.0mm

Jaw Width

1.5mm 2.0mm

Length

15.0cm/6.0in

19.5cm/7.75in

24.0cm/9.5in

30.0cm/11.75in

Product No.

060-510

060-512

060-514

060-516

Product No.

060-520

060-522

060-524

060-526



FORCEPS & CLAMPS - *Bi-Polar Forceps*

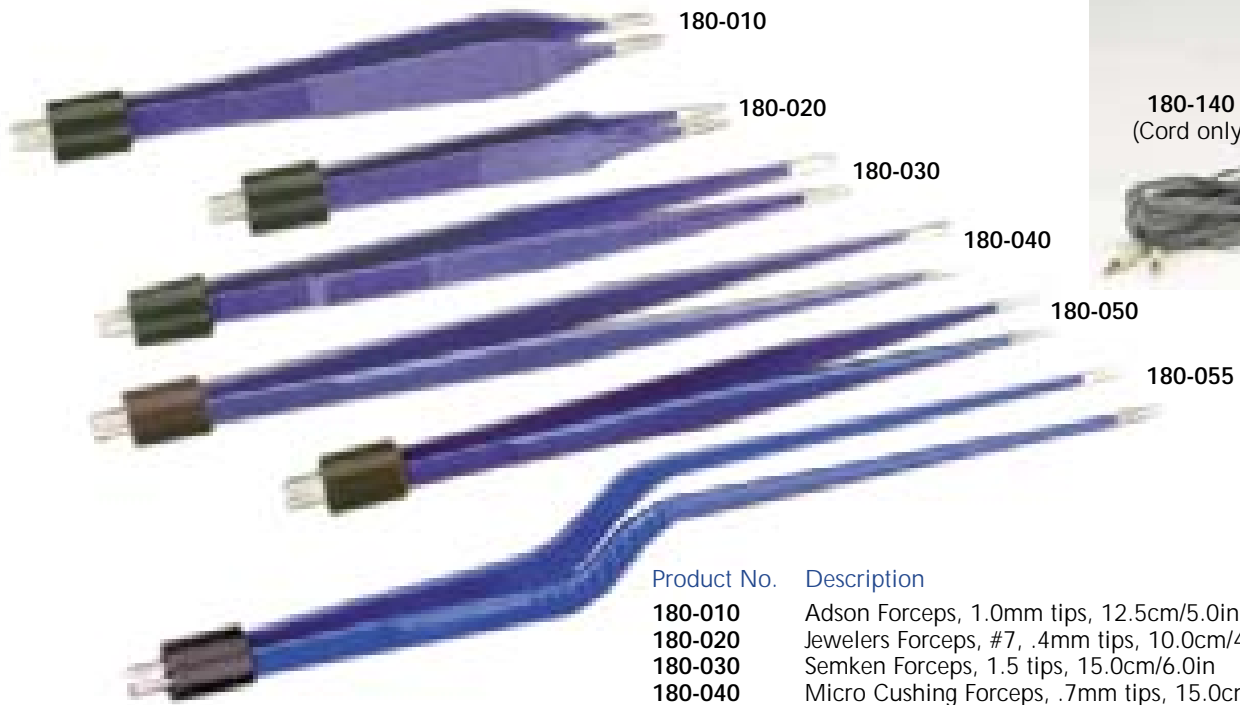

Product No.	Description
180-010	Adson Forceps, 1.0mm tips, 12.5cm/5.0in
180-020	Jewelers Forceps, #7, .4mm tips, 10.0cm/4.0in
180-030	Semken Forceps, 1.5 tips, 15.0cm/6.0in
180-040	Micro Cushing Forceps, .7mm tips, 15.0cm/6.0in
180-050	Cushing Forceps, 1.5mm tips, 18.0cm/7.0in
180-055	Bayonet Forceps, 1.0mm tips, 18.5cm/7.25in
180-140	Bi-Polar Cord, 12 feet, Reusable

Many other styles available. Please ask.

Jeweler Forceps

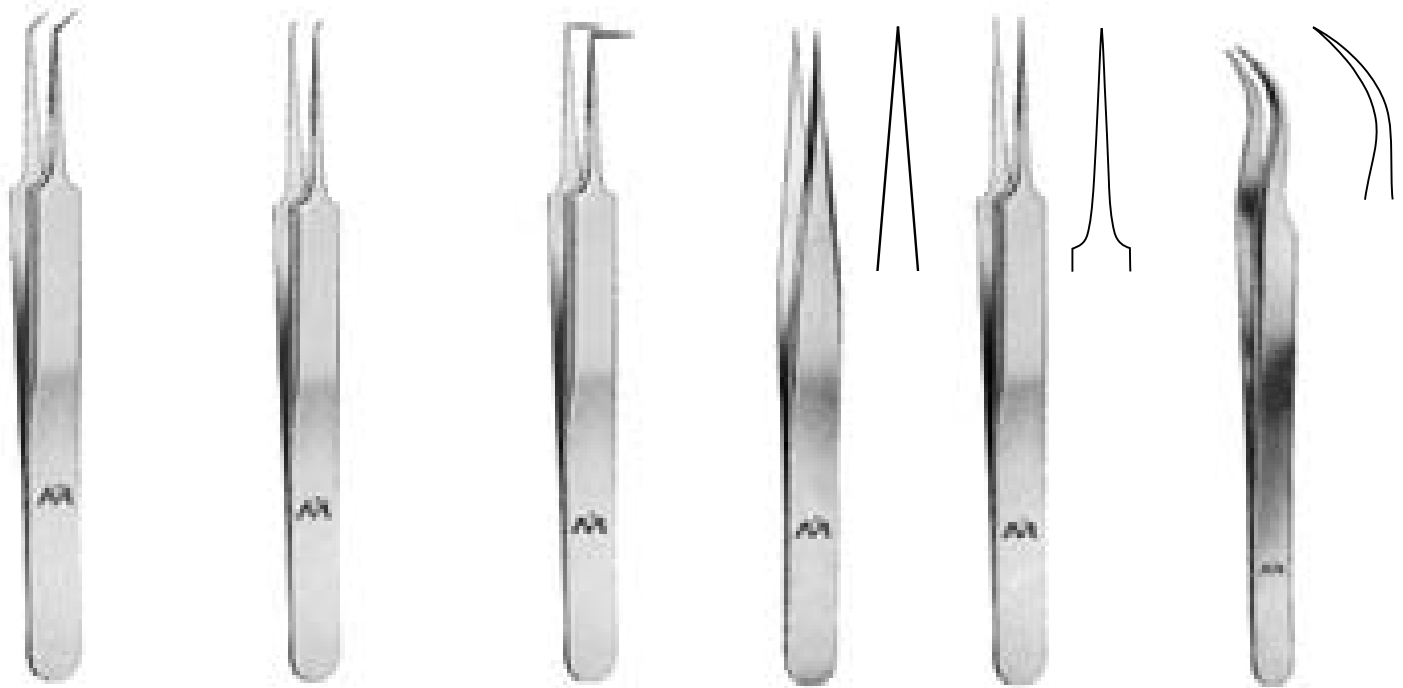

Jeweler Forceps for Hair Restoration

45° Angle Tip
11.0cm/4.25in

Product No.
060-330

45° Angle Tip, Delicate
11.0cm/4.25in

Product No.
060-331

90° Angle Tip
11.0cm/4.25in

Product No.
060-332

#3, Straight
12.0cm/4.75in

Product No.
060-336

#5
12.0cm/4.75in

Product No.
060-338

#7, Angled
12.0cm/4.75in

Product No.
060-340

Specialty Forceps

Blepharoplasty Forceps



440-323 440-319 440-321

Extra Fine

Product No.
440-323

Description

Extra Fine Hooks on
Castroviejo Forceps,
12.0cm/4.75in

Delicate

Product No.
440-319

Description

Delicate Hooks on
Adson Forceps,
13.0cm/5.0in

Standard

Product No.
440-321

Description

Standard Hooks on
Adson Forceps with Platform
13.0cm/5.0in



Green Fixation Forceps

Product No.
060-430

Description

With lock, 10mm tip. Grips tissue in
an atraumatic manner. Great for
Blepharoplasty procedures.
10.5cm/4.0in

060-420 - Without lock, 10mm tip



Griffith Brown Forceps

Product No.
060-183

Description - Length

Delicate 9 x 9 Teeth on
Castroviejo Forceps - 11.5cm/4.75in

Micro Forceps



Castroviejo Suturing Forceps

w/ Tying Platform, 1 x 2 teeth

10.0cm/4.0in

Product No.	Description
171-612	.12mm teeth
171-630	.3mm teeth
171-650	.5mm teeth
171-690	.9mm teeth



Tubingen Tying Forceps

Smooth Platform

10.0cm/4.0in

Product No.	Description
171-600	No teeth

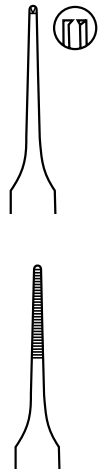

Bishop-Harmon Suture Forceps

9.0cm/3.5in

Product No.	Description
173-825	1 x 2, .5mm teeth
173-828	1 x 2, .8mm teeth
173-829	No teeth, .8mm tip



FORCEPS & CLAMPS - *Splinter & Suture Removal Forceps*

Used to Remove Sutures, Cilia or Splinters

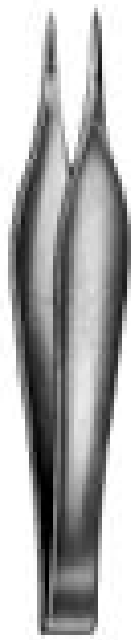

Feilchenfeld Splinter Forceps

Product No. Description
190-134 12.0cm/4.75in

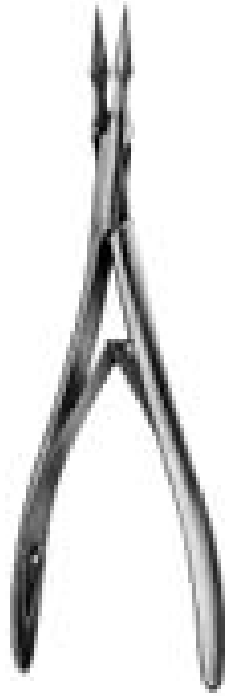

Virtus Splinter Forceps

Product No. Description
190-136 15.0cm/6.0in



Carmalt Splinter Forceps

Product No. Description
190-137 Angled, 11.0cm/4.25in
190-138 Straight, 11.0cm/4.25in

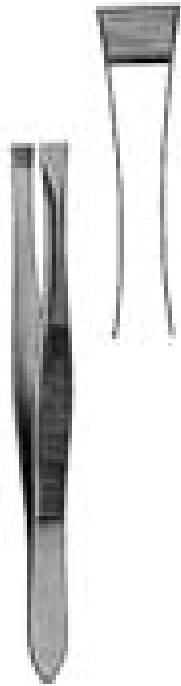

Littauer Cilia Forceps, Flat

9.0cm/3.5in
 Product No.
190-128

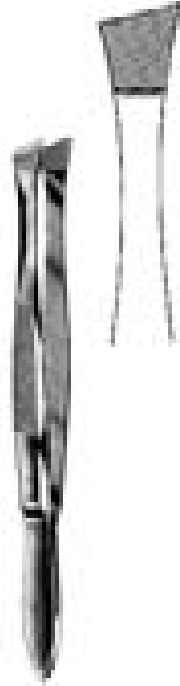

Littauer Cilia Forceps, Oblique

9.0cm/3.5in
 Product No.
190-129

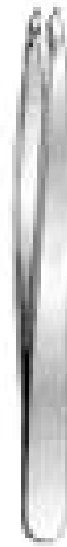

Swiss Cilia Forceps, Oblique

9.0cm/3.5in
 Product No.
060-342

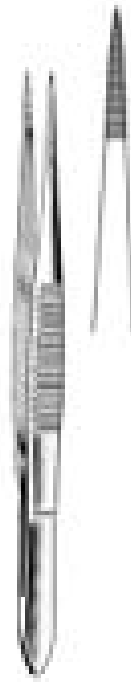

Marina Splinter Forceps

10.0cm/4.0in
 Product No.
190-143

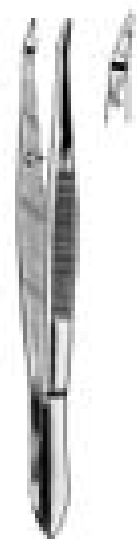

Barraquer (Kurth) Forceps

with Tying Platform
 10.0cm/4.0in
 Product No.
060-341

Specialty Forceps

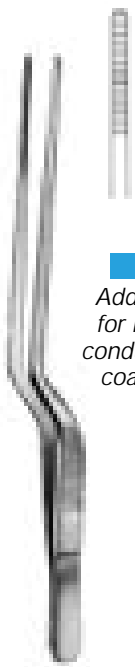
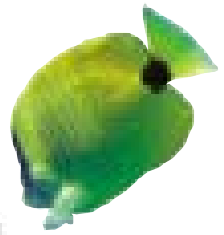

Add NC
for non-
conductive
coating

Jansen Bayonet
20.0cm/8.0in
060-344

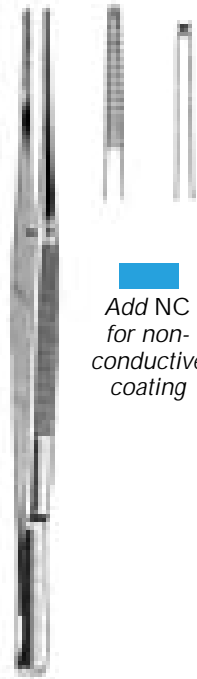

Add NC
for non-
conductive
coating

Taylor
18.0cm/7.0in - No teeth
060-345



Add NC
for non-
conductive
coating

Taylor Bayonet
18.0cm/7.0in
060-346 - No teeth
060-347 - 1 x 2 teeth

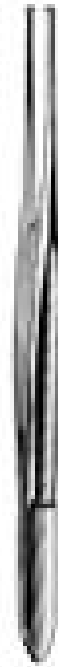

Add NC
for non-
conductive
coating

Cushing
17.0cm/6.75in
060-360 - no teeth
060-361 - 1 x 2 teeth

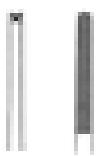

Add NC
for non-
conductive
coating



Cushing Bayonet
18.0cm/7.0in
060-348 - 1 x 2 teeth
060-349 - no teeth

Add NC
for non-
conductive
coating

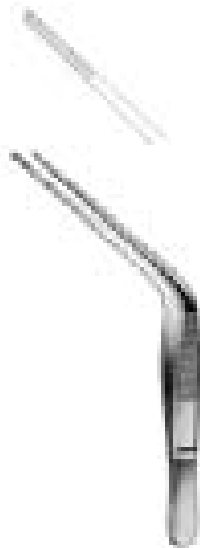

Wilde
12.5cm/5in
060-354



Add NC
for non-
conductive
coating



Lucae
Bayonet style
060-350 - 14.0cm/5.5in
060-352 - 16.0cm/6.5in



Allis Clamps
Baby Allis

Product No.	Description
160-005	4 x 5 teeth, 12.0cm/4.5in

Product No.	Description
160-013	3 x 4 teeth, 13.0cm/5.0in
160-114	4 x 5 teeth, 14.5cm/5.5in
160-115	4 x 5 teeth, 15.0cm/6.0in
160-215	5 x 6 teeth, 15.0cm/6.0in

FORCEPS & CLAMPS - Hemostatic Clamps



Kelly (Kelly-Rankin)

Product No.	Description
070-036	Straight, 14.0cm/5.5in
070-038	Curved, 14.0cm/5.5in
070-037	Straight, 16.0cm/6.25in
070-039	Curved, 16.0cm/6.25in



Crile (Crile-Rankin)

Product No.	Description
070-042	Straight, 14.0cm/5.5in
070-044	Curved, 14.0cm/5.5in
070-043	Straight, 16.0cm/6.25in
070-045	Curved, 16.0cm/6.25in



Halsted Mosquito (Adson)

Product No.	Description
070-330	Curved, 20.0cm/8.0in



Rochester-Pean

Product No.	Description
070-120	Straight, 16.0cm/6.25in
070-122	Straight, 18.0cm/7.0in
070-124	Straight, 20.0cm/8.0in
070-138	Curved, 16.0cm/6.25in
070-140	Curved, 18.0cm/7.0in
070-142	Curved, 20.0cm/8.0in

Longer sizes available



Mixer

Strongly Curved

Product No.	Description
070-340	14.0cm/5.5in
070-341	16.0cm/6.25in
070-342	19.0cm/7.5in
070-344	23.5cm/9.0in



Rochester-Oschner (Kocher)

Product No.	Description
070-066	Straight, 1 x 2 Teeth, 14.0cm/5.5in (Kocher)
070-068	Curved, 1 x 2 Teeth, 14.0cm/5.5in (Kocher)
070-152	Straight, 1 x 2 Teeth, 18.0cm/7.0in
070-154	Straight, 1 x 2 Teeth, 20.0cm/8.0in
070-162	Curved, 1 x 2 Teeth, 18.0cm/7.0in
070-164	Curved, 1 x 2 Teeth, 20.0cm/8.0in

Longer sizes available

Hemostatic Forceps

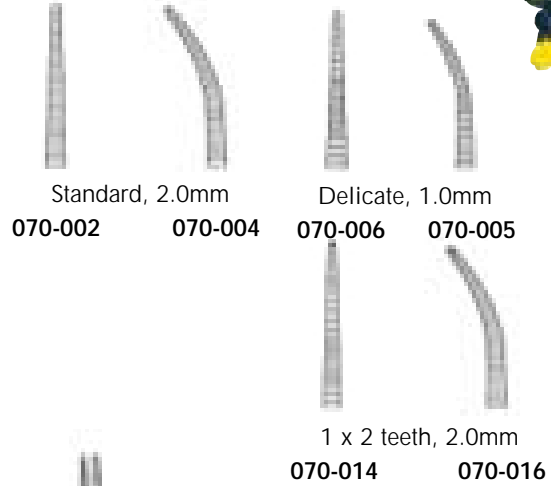
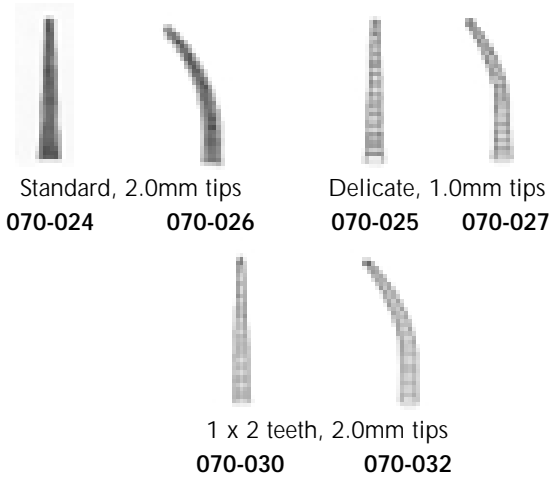

Hartman Mosquito

10cm/4in

Product No.	Description
070-024	Straight
070-025	Straight, Delicate
070-026	Curved
070-027	Curved, Delicate
070-030	Straight, 1 x 2 Teeth
070-032	Curved, 1 x 2 Teeth



Halsted Mosquito

13.0cm/5.25in

Product No.	Description
070-002	Straight
070-004	Curved
070-005	Curved, Delicate
070-006	Straight, Delicate
070-014	Straight, 1 x 2 Teeth
070-016	Curved, 1 x 2 Teeth



18.0cm/7.0in
070-240 Baby Adson, Curved

13cm/5.25in
070-007 Halsted (Peet) Angled

Towel Clips

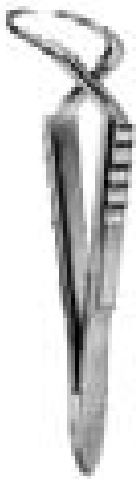

Jones

Product No.	Description
070-524	9.0cm/3.5in

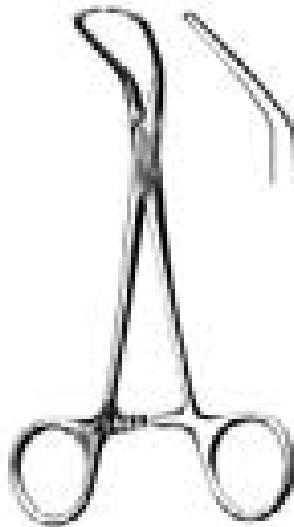

Backhaus

Product No.	Description
070-504	9.0cm/3.5in
070-506	13.0cm/5.25in



Lorna (Edna)

Product No.	Description
070-514	10.0cm/4.0in
070-515	13.0cm/5.25in

FORCEPS & CLAMPS

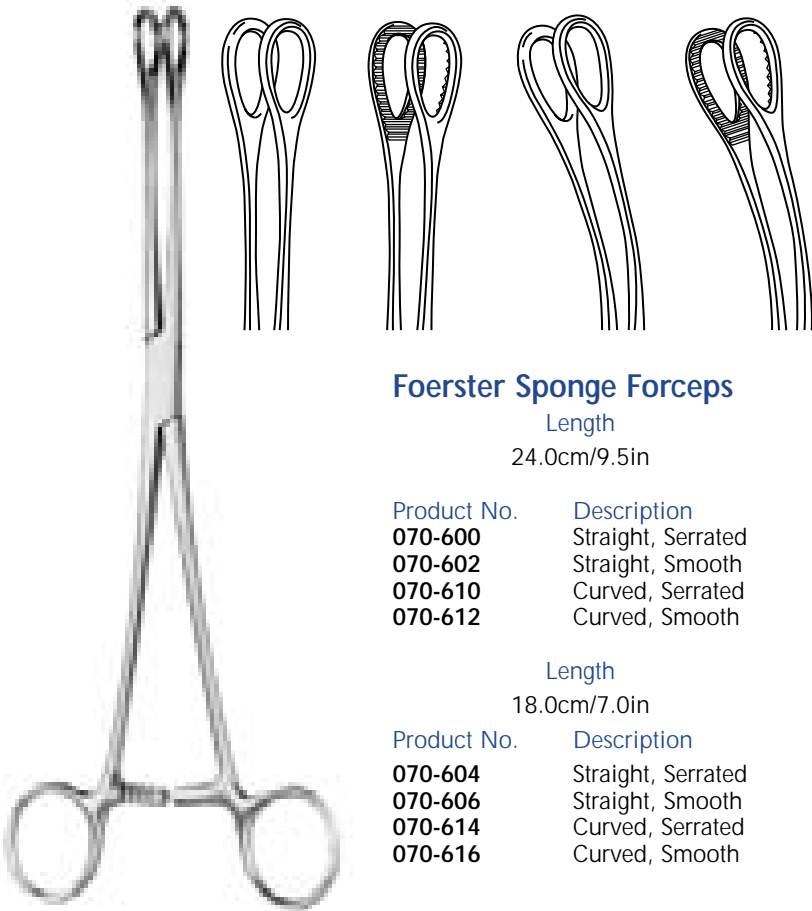

Foerster Sponge Forceps

Length
24.0cm/9.5in

Product No.	Description
070-600	Straight, Serrated
070-602	Straight, Smooth
070-610	Curved, Serrated
070-612	Curved, Smooth

Length
18.0cm/7.0in

Product No.	Description
070-604	Straight, Serrated
070-606	Straight, Smooth
070-614	Curved, Serrated
070-616	Curved, Smooth

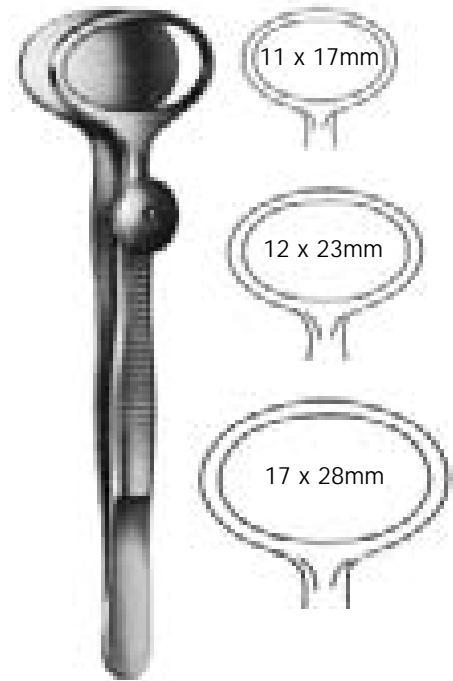

Desmarres Chalazion Clamp

9.0cm/3.5in

Product No.	Description
190-601	Small
190-602	Medium
190-603	Large

Fill Tube Inserter Clamp

No breast surgeon should be without this handy fill tube inserter clamp. Useful to reinsert the fill tube into the breast implant valve if the fill tube inadvertently slips out during the filling procedure or if after removal more or less saline is desired.

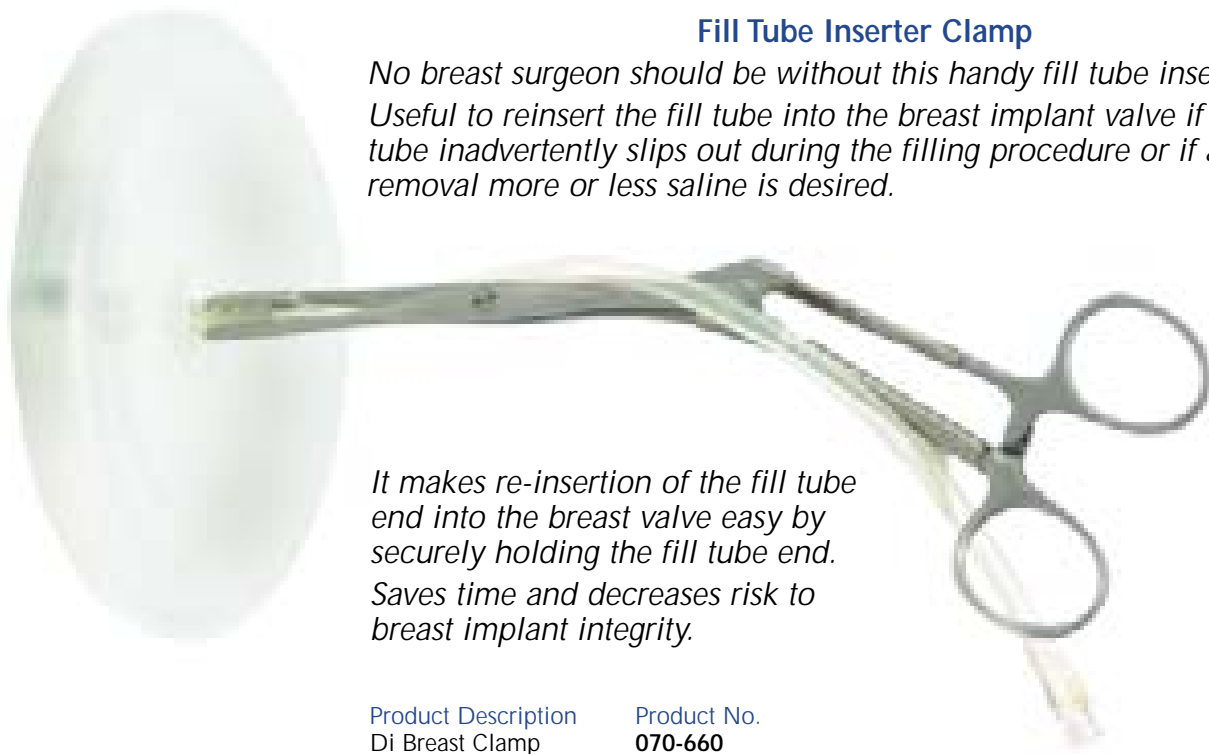

It makes re-insertion of the fill tube end into the breast valve easy by securely holding the fill tube end. Saves time and decreases risk to breast implant integrity.

Product Description	Product No.
Di Breast Clamp	070-660

Standard Needle Holders

Micro Needle Holders



NEEDLE HOLDERS

NEEDLE HOLDERS



Recommended for 4/0 to 6/0 suture

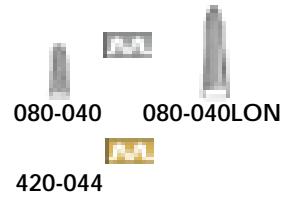

Derf
12.0cm/4.75in



Recommended for 4/0 to 6/0 suture



Baby Webster
12.0cm/4.75in



Recommended for 6/0 and smaller suture

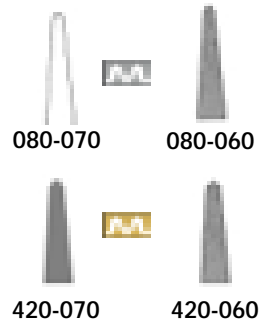

Webster
13.0cm/5.0in



Recommended for 5/0 and smaller suture

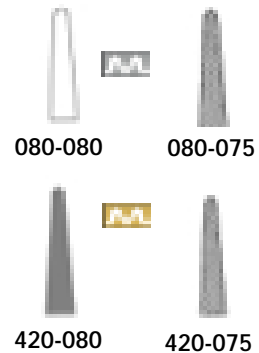

Halsey
13.0cm/5.0in

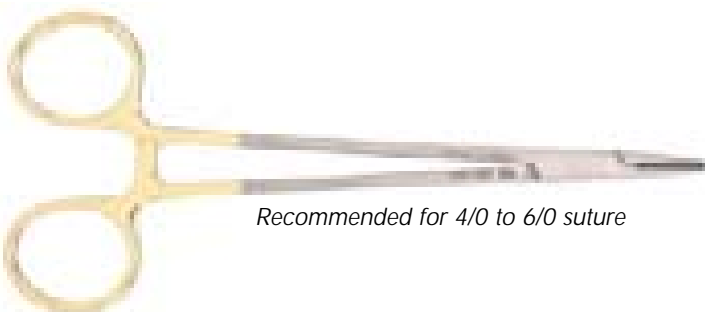

Recommended for 4/0 to 6/0 suture

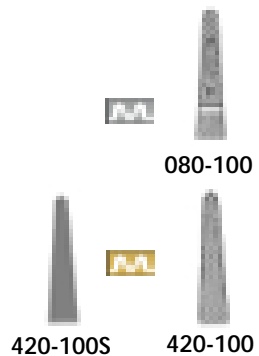

Crilewood
15.0cm/6.0in

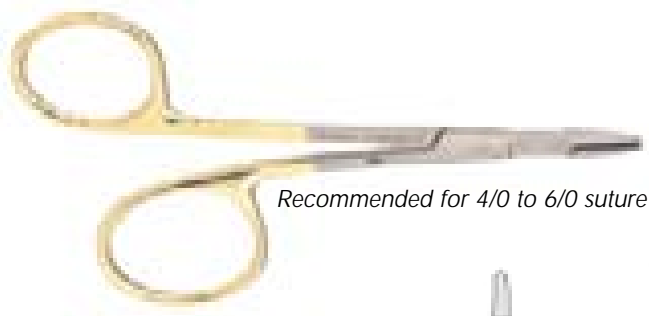

Recommended for 4/0 to 6/0 suture



420-211

11.0cm/4.25in



420-210

13.0cm/5.25in



420-213

16.0cm/6.25in

080-250

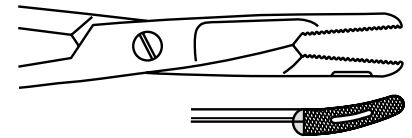

Gillies

16.0cm/6.25in
Needleholder/Scissors combo
with Offset Rings

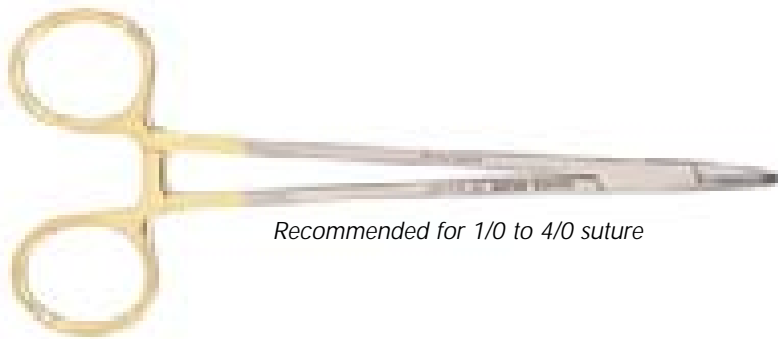

Recommended for 1/0 to 4/0 suture



Mayo-Hegar

Product No.	Description
080-140	15.0cm/6.0in
080-160	18.0cm/7.0in
080-180	20.0cm/8.0in
080-200	23.0cm/9.0in
080-220	26.5cm/10.5in

Product No.	Description
420-314	14.0cm/5.5in
420-316	16.0cm/6.25in
420-318	18.0cm/7.0in
420-320	20.0cm/8.0in
420-314LH	14.0cm/5.5in - Left hand
420-317	18.0cm/7.0in - Smooth Jaw

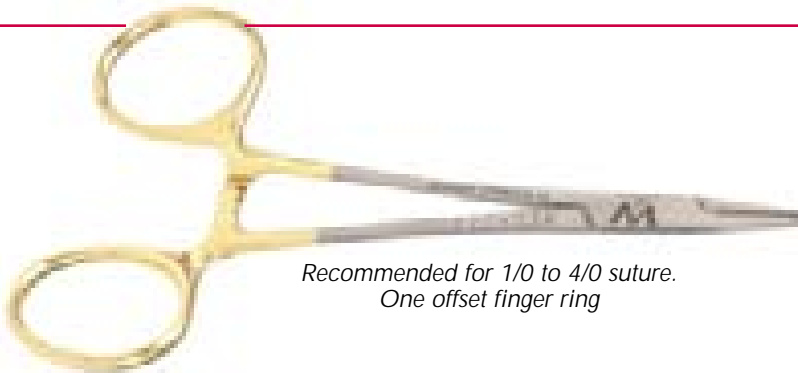

Recommended for 1/0 to 4/0 suture.
One offset finger ring



Neivert

Product No.	Description
080-216	13.0cm/5.0in
420-216	13.0cm/5.0in

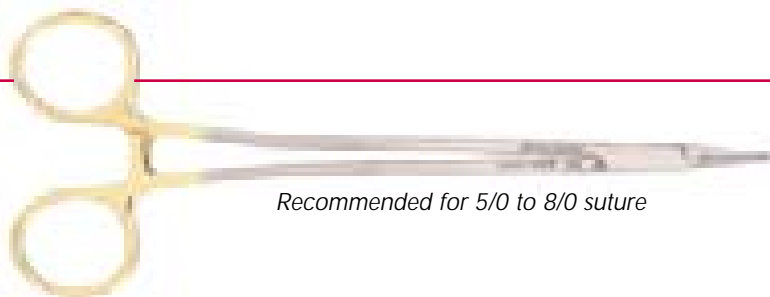

Recommended for 5/0 to 8/0 suture

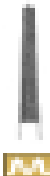

Vascular (Delicate)

Product No.	Description
420-285	15.0cm/6.0in, Smooth Jaw
420-286	15.0cm/6.0in, Serrated Jaw
420-288	18.0cm/7.0in, Serrated Jaw
420-290	20.0cm/8.0in, Serrated Jaw

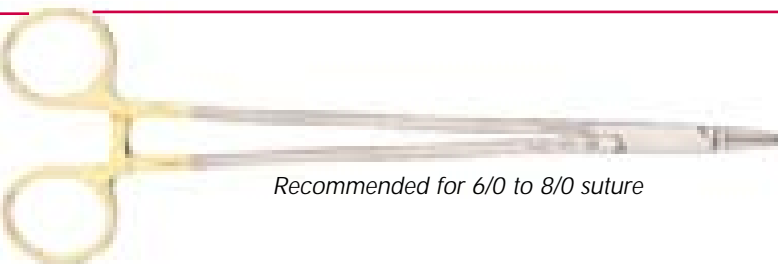

Recommended for 6/0 to 8/0 suture



Micro-Ryder

Product No.	Description
420-452	13.0cm/5.0in
420-454	15.0cm/6.0in
420-456	18.0cm/7.0in
420-460	23.0cm/9.0in
420-462	30.5cm/12.0in



NEEDLE HOLDERS

Olsen-Hegar Needle Holders with Scissors

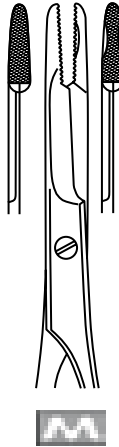

Product No.	Description
080-510	Smooth Jaw, 12.0cm/4.75in
080-512	Serrated Jaw, 12.0cm/4.75in
080-514	Serrated Jaw, 14.0cm/5.5in
080-516	Serrated Jaw, 16.0cm/6.25in
080-518	Serrated Jaw, 18.0cm/7.0in



Product No.	Description
420-912	Serrated Jaw, 12.0cm/4.75in
420-913	Smooth Jaw, 12.0cm/4.75in
420-914	Serrated Jaw, 14.0cm/5.5in
420-915	Smooth Jaw, 14.0cm/5.5in
420-917	Serrated Jaw, 16.5cm/6.5in
420-918	Serrated Jaw, 18.0cm/7.0in

Add LH for left-handed

Micro Needle Holders

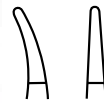
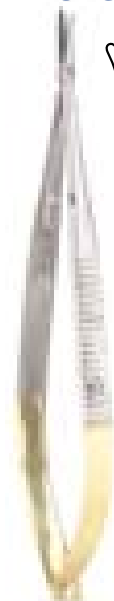
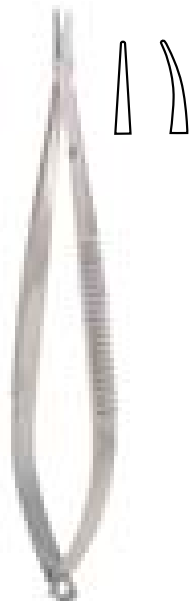

Castroviejo Needle Holder

Flat handle, 14.0cm/5.5in

Product No.	Description	Product No.	Description
172-210	Straight, w/o Lock	172-217	Straight, with lock
172-215	Straight w/ Lock		14.0cm/5.5in
172-310	Curved w/o Lock		TC inserts
172-315	Curved w/ Lock	172-317	Curved, with lock
			14.0cm/5.5in
			TC inserts



Barraquer Micro Needle Holder

Round handles, 13.0cm/5.0in

Product No.	Description
172-329	Straight Jaw w/o Lock,
172-330	Curved Jaw w/o Lock
172-331	Straight Jaw w/ Lock
172-333	Curved Jaw w/ Lock

Round handles, 18.0cm/7.0in

Product No.	Description
172-418	Straight Jaw w/o Lock,
172-518	Curved Jaw w/o Lock
172-618	Straight Jaw w/ Lock
172-718	Curved Jaw w/ Lock

Breast Retractors & Dissectors

Retractors

Special Retractors

Tissue Wound Retractors

Self-Retaining Skin Retractors

Rake Retractors



RETRACTORS & SKIN & LOOKS

RETRACTORS & SKIN HOOKS - Breast Retractors & Dissectors



Biggs Mammoplasty Retractor

Product No.	Blade Size/Description
110-667-30	30.0mm wide fenestrated blade, with fiberoptic light and suction
110-667-50	50.0mm wide fenestrated blade, with fiberoptic light and suction



Double-Ended Breast Retractor

31cm/12.25 in length

Product No.	Blade Size
110-653	37.0 x 70.0mm and 22.0 x 54.0mm
110-653L	With Fiberoptic Light

See page 8 for more

To add Fiberoptic Light, add **L** to the product number. To add Suction, add **S** to the product number.

To add Fiberoptic Light and Suction, add **LS** to the product number.

To add Endoscopic Sheath, add **E** to the product number. **E** requires 15cm length minimum blade and 15mm width minimum.

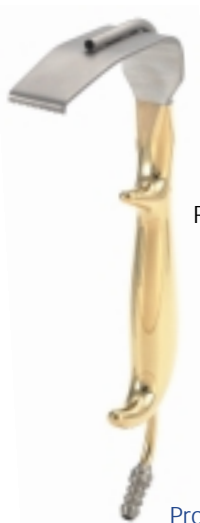

Product shown is Tebbetts Style Retractor with suction (**110-685S**)

Tebbetts Style
(with tooth serrated end)

Product No.	Blade Size (length x width)
110-690	80mm x 16mm
110-685	100mm x 25mm
110-686	120mm x 25mm
110-687	120mm x 30mm
110-688	150mm x 25mm
110-689	150mm x 30mm

Product shown is Ferriera Style Retractor with Fiberoptic Light and Suction (**110-676LS**)

Ferriera Style
(with smooth end)

Product No.	Blade Size (length x width)
110-672	80mm x 16mm
110-675	100mm x 25mm
110-676	120mm x 25mm
110-677	120mm x 30mm
110-678	150mm x 25mm
110-679	150mm x 30mm

Autoclavable Fiberoptic Cord

ACMI Light Source End with Storz™ Instrument End

Product No.	Length
350-372	3 meters (10 ft.)





Agris-Dingman Transauxillary Breast Dissector

Pair: Left/Right
 Product No. Description
 110-382 40.0cm/15.75in.

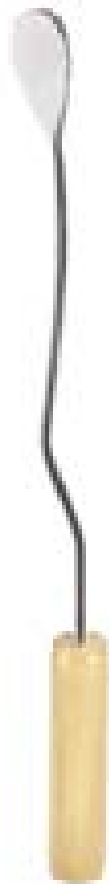

MacCollum-Dingman Transauxillary Breast Dissector

Angled Shaft
 Product No. Description
 110-384 31.5cm/12.5in



Reynolds Transauxillary Breast Dissector

Fenestrated
 Product No. Description
 110-380 40.0cm/15.75in
 Non-Fenestrated,
 for breasts and buttocks
 Product No. Description
 110-386 33cm/13in



D-Bra

Easy to install. Can be used as a wrap and straps slip up after recovery. Latex free. Velcro® front. White only.
 S; M; L; XL
 Product No. **GADBra**

(See page 74 for more bra options)

RETRACTORS & SKIN HOOKS - *Retractors*



Aufricht Nasal Retractor

Product No.	Blade Size
200-252	7.0mm wide, 16.0cm/6.25in length
200-250	10.0mm wide, 16.0cm/6.25in length
200-252L	With Fiberoptic Light
200-250L	With Fiberoptic Light



Wieder

Product No.	Blade Size
110-669	28.0mm serrated
110-670	36.0mm serrated
110-669L	With Fiberoptic Light
110-670L	With Fiberoptic Light



Add NC
for non-conductive
coating

Farabeuf

Set of 2

Product No.	Description
110-121	12.0cm/4.75in
110-125A	15.0cm/6.0in

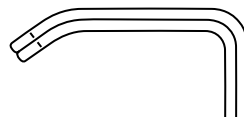

Add NC
for non-conductive
coating

U.S. Army (Parker-Langenbeck)

Set of 2

Product No.	Description
110-122	21.5cm/8.5in



Ribbon

18cm/7in length

Product No.	Width
110-123	6.0mm / .25in (1/4in)
110-124	10.0mm / .375in (3/8in)
110-125	13.0mm / .5in (1/2in)
110-126	15.0mm / .625in (5/8in)
110-127	19.0mm / .75in (3/4in)
110-129	25.0mm / 1.0in

33cm/13in. length

110-130	19mm / .75in
110-132	25mm / 1.0in
110-136	31mm / 1.25in
110-140	50mm / 2.0in
110-142	75mm / 3.0in

Add NC
for non-conductive
coating

To add Suction, add **S**
to the product number.
Add **NC** for non-conductive coating.



Deaver Retractor

with Fiberoptic Blade

Product No.	Description
110-663	16.0mm x 9.0in
110-664	25.0mm x 9.0in
110-665	38.0mm x 13.0in
110-666	25.0mm x 13.0in

Without Fiberoptic Light

110-200	25mm x 23cm/1.0in x 9in
110-202	25mm x 30cm/1.0in x 12in
110-206	38mm x 30cm/1.5in x 12in
110-208	51mm x 30cm/2.0in x 12in
110-219	19mm x 18cm/.75in x 7in



Heaney/Simon Retractor

Fiberoptic Blade

Product No.	Blade Size
254-642	1.0in x 5.0in



Lighted Freeman Flap Retractor

110-320	12.0mm wide, 20cm/8.0in
110-320A	Without fiberoptic light

Marina Medical can customize any retractor. Please call your Account Manager for information regarding non-conductive coating, fiberoptics and sizing.



RETRACTORS & SKIN HOOKS - *Special Retractors*



Jaeger Lid Plate

11.0cm/4.25in

Product No.

Description

110-046

Stainless

110-046NC

Non-conductive coating

110-046L

Laser



Desmarres Lid Retractor

Length 14cm/5.5in

Insulated

Stainless

Non-Conductive

Product No.

Description

Product No.

Description

110-050

10.0mm

110-050NC

10.0mm

110-052

12.0mm

110-052NC

12.0mm

110-054

14.0mm

110-054NC

14.0mm

110-056

16.0mm

110-056NC

16.0mm



Add NC
for non-
conductive
coating



Kasden Double-Ended Retractor

Product No.

Description

110-084

16.0cm/6.25in

Add NC
for non-
conductive
coating

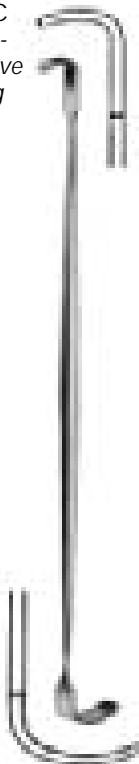

Ragnell-Davis

Product No.

Description

110-073

15.0cm/6.0in

Add NC
for non-
conductive
coating

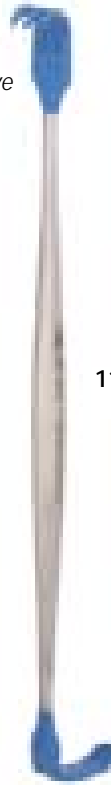

Senn-Mueller

16.0cm/6.25in

Product No.

Description

110-074

3-Prong, Sharp

110-076

3-Prong, Blunt

110-074NC

Add NC
for non-
conductive
coating

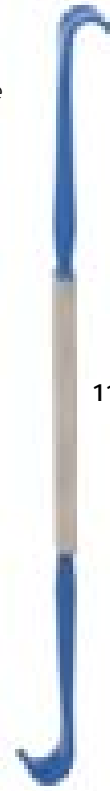

Double-Ended Desmarres

Product No.

Description

110-058

15.0cm/6.0in

8/10mm blades

110-058NC

Tissue Wound Retractors

SELF-RETAINING SKIN RETRACTORS

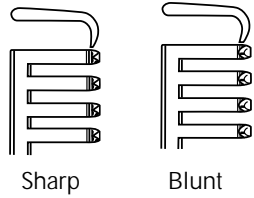

Heiss

Self-Retaining
10cm/4.0in

Product No.	Description
110-480	Blunt blades
110-481	Sharp blades

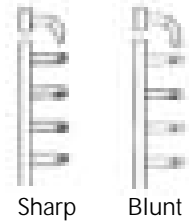

Alm

Self-Retaining
10cm/4.0in

Product No.	Description
110-483	Blunt blades
110-484	Sharp blades

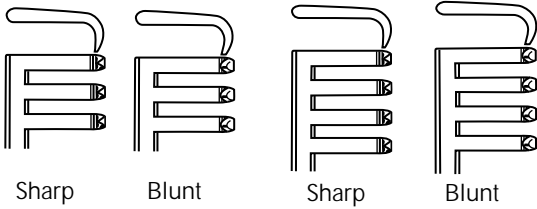

Weitlaner

2 x 3 Prongs
11.0cm/4.5in

Product No.	Description
110-509	Sharp blades
110-513	Blunt blades

3 x 4 Prongs
12.5cm/5.0in

Product No.	Description
110-609	Sharp blades
110-613	Blunt blades

3 x 4 Prongs
16.5cm/6.5in

Product No.	Description
110-614	Sharp blades
110-615	Blunt blades

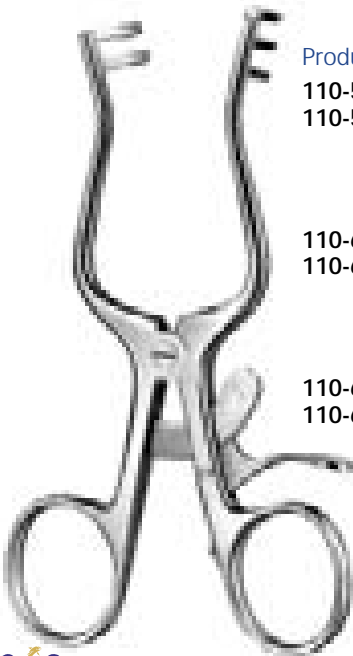

Gelpi

Product No	Description
110-365	11.0cm/4.5in
110-366	16.0cm/6.0in
110-367	18.0cm/7.0in



Bow Retractors

Product No	Description
<i>without teeth</i>	
190-390	14.0cm/5.5in
190-391	15.0cm/6.0in
190-392	18.0cm/7.0in
<i>with teeth</i>	
190-393	14.0cm/5.5in
190-394	15.0cm/6.0in
190-395	18.0cm/7.0in

RETRACTORS & SKIN HOOKS - *Skin Hooks & Retractors*



 Add NC for non-conductive coating

Fomon
 16.0cm/6.25in
 Product No. **190-163**
 Description Single-Ended Ball

Product No. **190-167**
 Description Double-Ended Ball



Frazier
 12.5cm/5.0in
 Product No. **190-168**
 Description Dura Hook, Blunt

Product No. **190-169**
 Description Dura Hook, Sharp



Tyrell (Iris)
 15.0cm/6.0in
 Product No. **190-170**
 Description Single, Very Delicate, Round Handle



Graefe (Iris)
 12.5cm/5.0in
 Product No. **190-179**
 Description Single, Very Delicate, Flat Handle

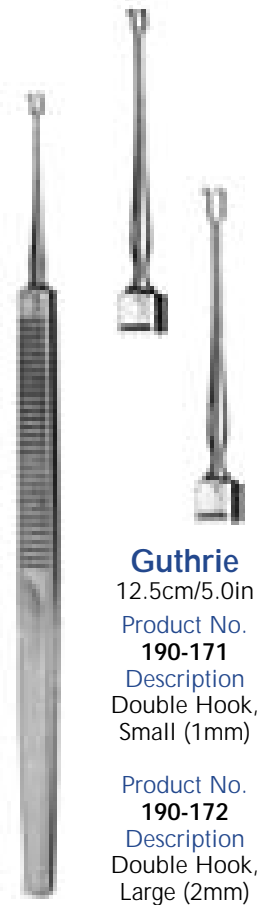

Guthrie
 12.5cm/5.0in
 Product No. **190-171**
 Description Double Hook, Small (1mm)

Product No. **190-172**
 Description Double Hook, Large (2mm)



Lahey
 12.0cm/4.75in
 Product No. **190-173**
 Description Single Prong, Round Handle

Product No. **190-177**
 Description Double Prong, Round Handle



Barsky
 16.0cm/6.25in
 Product No. **190-1832**
 Description Nasal tenaculum, 2 sharp prongs, 9mm width



Rollet (Knapp)
 14.0cm/5.75in
 Product No. **190-174**
 Description 4-Prong, Sharp

Product No. **190-178**
 Description 4-Prong, Blunt

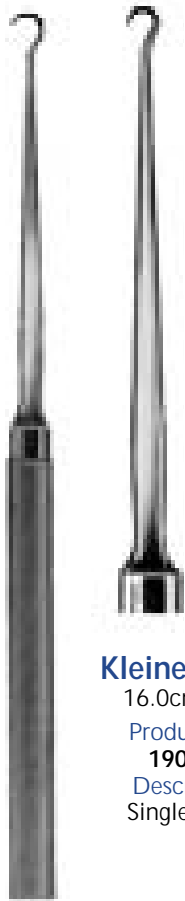

Kleinert-Kutz

16.0cm/6.5in

Product No.

190-176

Description

Single Prong

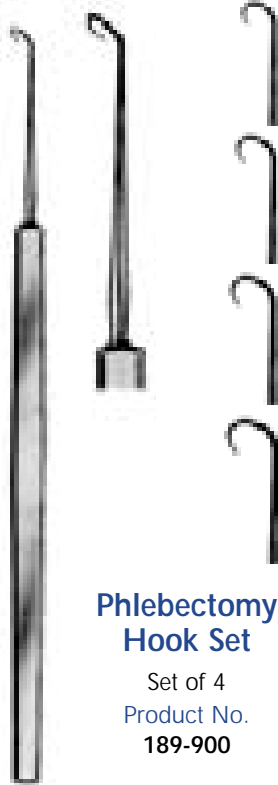

**Phlebectomy
Hook Set**

Set of 4

Product No.

189-900

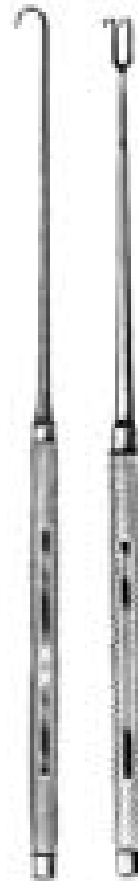

Add NC
for non-
conductive
coating

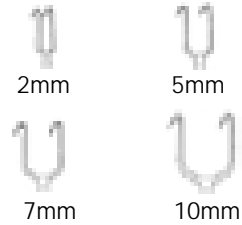

Joseph

15.0cm/6.0in

Description

Single Prong

Double Prong, 2.0mm width

Double Prong, 5.0mm width

Double Prong, 7.0mm width

Double Prong, 10.0mm width

Product No.

190-180

190-181

190-182

190-183

190-1831



**Cottle-Neivert
Retractor/
Needle Guide**

21.0cm/8.25in

Product No.

190-165

**Millard Double
Thumb Hook
(Kilner-Martinez)**

10mm wide, length

8.5cm/3.5in

Product No.

190-219

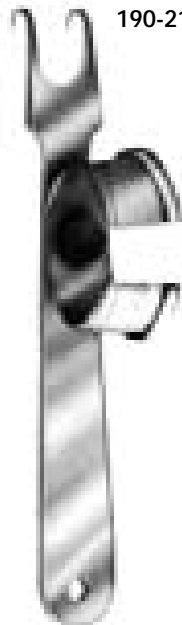

Cottle Thumb Hook

Product No. Description

190-218

Double Prong, Sharp,
8.0mm w/ Adjustable
Thumb Ring

Double Prong Thimble Hook

Product No.

190-217

Description

Double prong, Sharp, 18.0mm



RETRACTORS & SKIN HOOKS - *Rake Retractors*



**Gorney Rake
Spring Neck**

4 sharp prongs
 Product No.
110-332
 Description
 1.5in wide, 3.0in length



Coronal Brow Lift

7 sharp prongs
 Product No.
110-338
 Description
 2.75in wide, 7.0in long

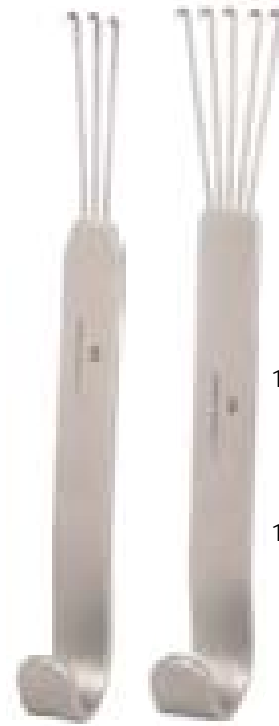

**Anderson
Claw**

Product No.
110-342
 Description
 3 prongs,
 12.0cm/4.75in
 Product No.
110-344
 Description
 5 prongs,
 12.0cm/4.75in



Freeman Rake

Product No.	Description
110-333	4 Sharp Prongs, 1.5in width, 4.0in length
110-334	4 Blunt Prongs, .75in width, 7.0in length
110-335	4 Sharp Prongs, 1.5in width, 7.0in length
110-336	4 Sharp Prongs, .875in width, 7.0in length
110-337	4 Sharp Prongs, 1.0in width, 4.25in length
110-340	4 Sharp Prongs, .75in width, 2.0in length with thumb ring



Yancoskie Abdominoplasty Retractor

Product No.
110-331
 Description
 6 Sharp Prongs, 15.0cm/6.0in width,
 18.0cm/7in. length



CAR, NOSE & THROAT

- Nasal Retractors
- Periosteal Elevators
- Otobraders
- Mirrors
- Ear Loops
- Curettes
- Rasps
- Chisels & Osteotomes
- Cartilage Crushers
- Rongeurs & Bone Cutters
- Rhinoplasty Sets
- Alligator & Cupped Forceps

EAR, NOSE & THROAT - *Nasal Series Specialty Retractors*

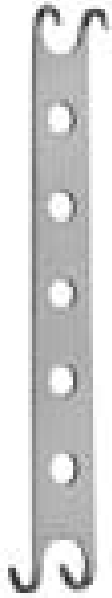

Converse Alar Retractor

Double ended, sharp,
12.0cm/4.75in
Product No.
110-648

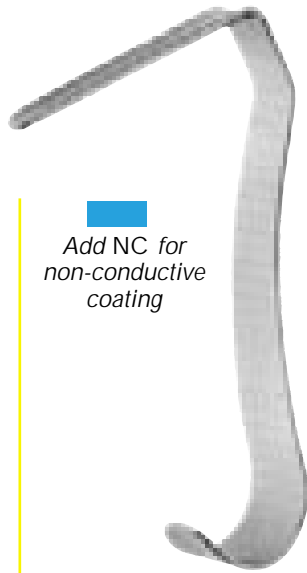

Add NC for non-conductive coating

Maliniac Nasal Retractor

11.0cm/4.25in

Product No. Blade Size
110-651 11.0mm x 44.0mm blade,
110-651L **With Fiberoptic Light**



Add NC for non-conductive coating

Converse Nasal Retractors

9.5cm/3.75in Length

Product No.	Description
190-304	16mm x 10mm Blade
190-305	30mm x 12mm Blade
190-308	40mm x 13mm Blade
190-309	55mm x 13mm Blade

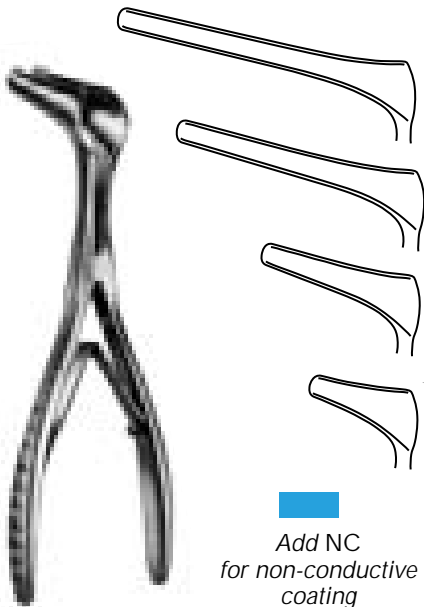

Killian Nasal Speculum

Narrow Blades, Full Internal Groove
14.0cm/5.5in

Product No.	Description
190-293	40mm Blade
190-294	55mm Blade
190-295	75mm Blade
190-296	90mm Blade

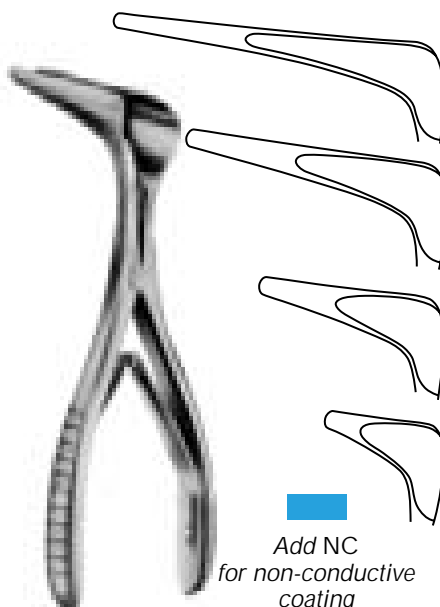

Cottle Nasal Speculum

Narrow Blades, Partial Internal Groove
15.0cm/6.0in

Product No.	Description
190-310	35mm Blade
190-311	50mm Blade
190-312	75mm Blade
190-306	90mm Blade

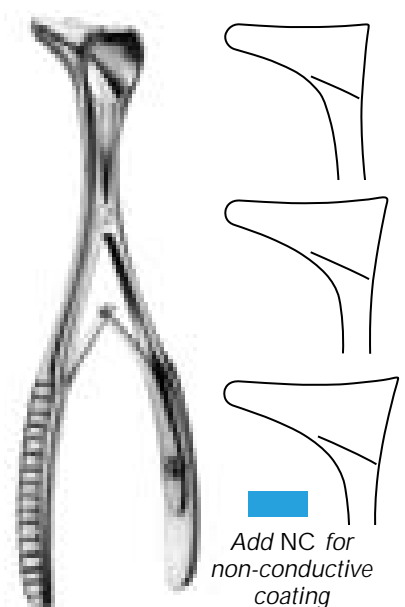

Vienna Nasal Speculum

14.0cm/5.5in

Product No.	Description
190-301	Small Blade, 20mm
190-302	Medium Blade, 25mm
190-303	Large Blade, 30mm

Periosteal Elevators

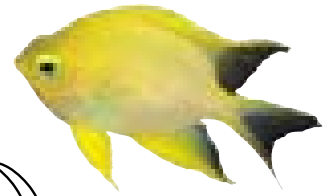

Joseph
18.0cm/7.0in
Product No. **190-248**
Description
Cottle Handle,
Curved, 4.0mm wide blade

Freer
18.0cm/7.0in
Double-Ended
Product No. **190-250**
Description
S/B, 5.0mm tip,
Round handle

McKenty
20.0cm/8.0in
Product No. **190-253**
Description
Curved,
3.0mm wide blade,
Flat handle

Cottle Periosteal
19.0cm/7.5in
Product No. **190-254**
Description
Slightly curved,
4.0mm tapered
blade

Cottle Septum
23.0cm/9.0in
Product No. **190-255**
Description
Double-Ended,
Graduated in Cm

Williger Elevator
16cm/6.25in
Product No. **190-249**
Description
4.0mm Sharp Blade,
Slightly curved

Parkes Nasal
15.0cm/6.0in
Product No. **110-085**
Description
Strongly curved,
6.0mm wide blade

EAR, NOSE AND THROAT

Billeau Ear Loops

Flexible, 16.5cm/6.5in



Product No.	Description
190-101	Size #1
190-102	Size #2
190-103	Size #3

Buck Ear Curettes

16.5cm/6.5in

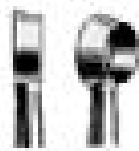
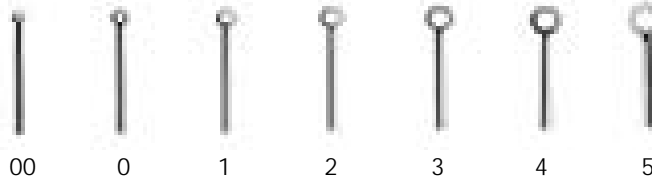

Sharp, Straight

Product No.

- 190-104-00
- 190-104
- 190-105
- 190-106
- 190-107
- 190-108
- 190-109

Description

- #00, Sharp, Straight
- #0, Sharp, Straight
- #1, Sharp, Straight
- #2, Sharp, Straight
- #3, Sharp, Straight
- #4, Sharp, Straight
- #5, Sharp, Straight



Blunt, straight

Product No.

- 190-114A
- 190-115
- 190-116
- 190-117
- 190-118

Description

- #0, Blunt, Straight
- #1, Blunt, Straight
- #2, Blunt, Straight
- #3, Blunt, Straight
- #4, Blunt, Straight

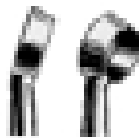

Sharp, Angled

Product No.

- 190-110
- 190-111
- 190-112
- 190-113
- 190-114

Description

- #0, Sharp, Angled
- #1, Sharp, Angled
- #2, Sharp, Angled
- #3, Sharp, Angled
- #4, Sharp, Angled

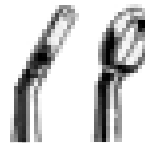

Blunt, Angled

Product No.

- 190-1190
- 190-1191
- 190-1192
- 190-1193
- 190-1194

Description

- #0, Blunt, Angled
- #1, Blunt, Angled
- #2, Blunt, Angled
- #3, Blunt, Angled
- #4, Blunt, Angled

Double-Ended Disposable Ear Curettes



Mini-Loop

Curve-Loop

Child-Scoop

Product No.

- P103-8043
- P103-8042
- P103-8041

Description

- Mini-Loop. For hardened wax
- Curve-Loop. For general procedures
- Child-Scoop. For smaller children and infants

50 per box



Laryngeal Mirrors with Handle



Product No.	Description	Product No.	Description
190-078	#000	190-085	#5
190-079	#00	190-086	#6
190-080	#0	190-087	#7
190-081	#1	190-088	#8
190-082	#2	190-089	#9
190-083	#3	190-090	#10
190-084	#4		

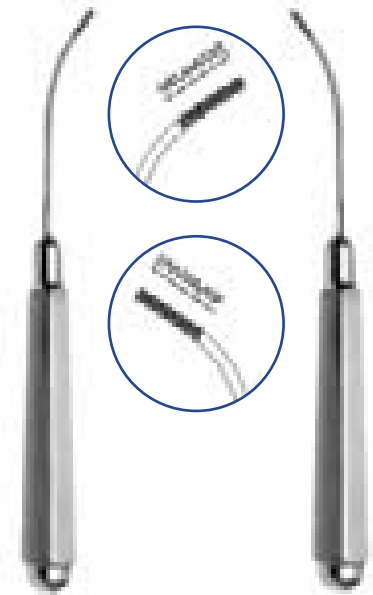

Dingman Otopraders

14.0cm/5.5in

Product No.	Description
201-095	Left and right pattern, set of 2

Glass Bead Mirror Warmer

- *Unsurpassed convenience in warming mirrors during laryngeal examinations*
- *Simply immerse the mirror into the hot beads for 3 to 5 seconds when needed*
- *Thermal wall remains cool and safe to touch*

Product No.	Description
P1006131	Mirror Warmer and Glass Beads (110V)
P1006132	Mirror Warmer and Glass Beads (220V)
P1006105	Replacement Beads

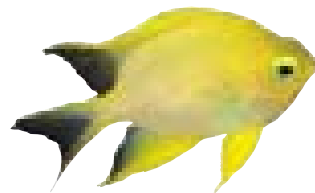

EAR, NOSE AND THROAT - *Nasal Rasps*

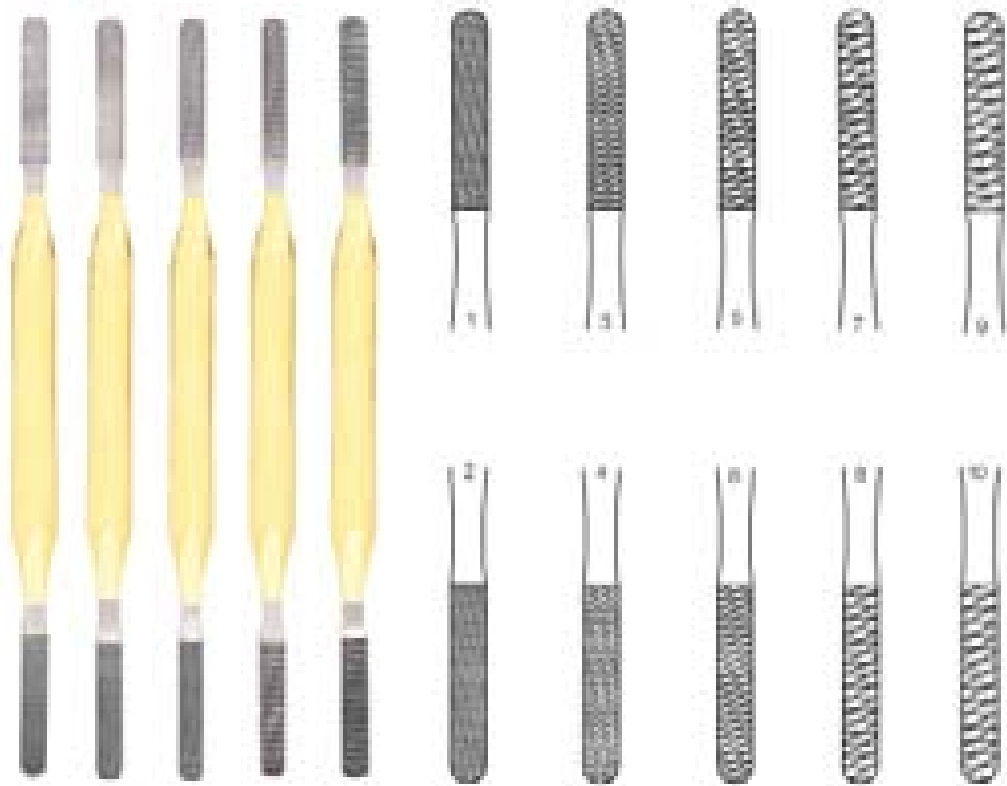

Fomon Nasal Rasps - Diamond Jaw

Double-Ended, Tungsten Carbide
20.0cm/8.0in

Product No.	Description
200-201	1/2, Very Fine
200-203	3/4, Medium Fine
200-205	5/6, Medium
200-207	7/8, Medium Coarse
200-209	9/10, Very Coarse

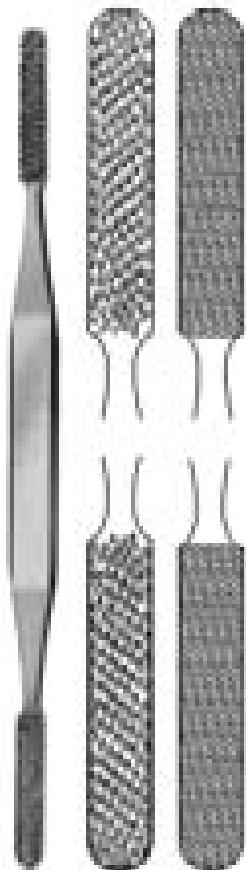

Fomon Nasal - 4-Sided

20.0cm/8.0in
Double-Ended
Product No. **200-215**
Description
Fine and coarse teeth in both flat and convex

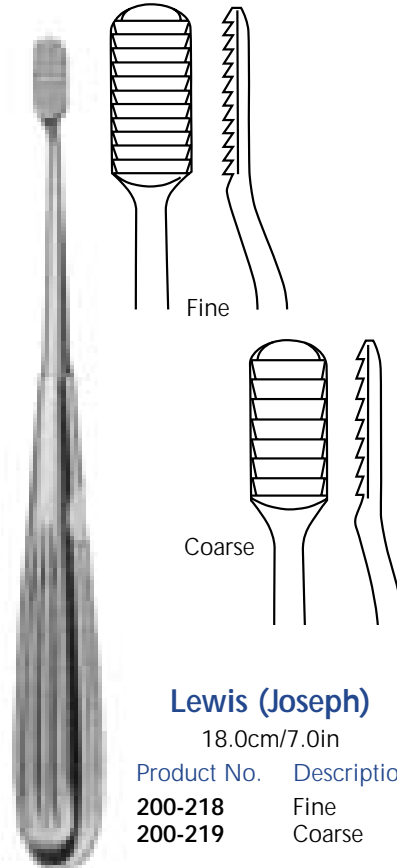

Lewis (Joseph)

18.0cm/7.0in
Product No. Description
200-218 Fine
200-219 Coarse

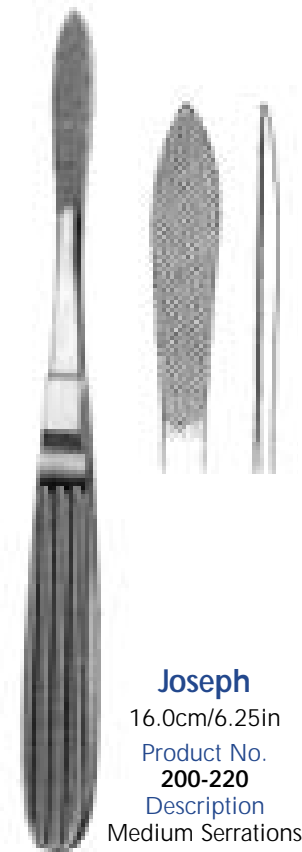

Joseph

16.0cm/6.25in
Product No. Description
200-220 Medium Serrations

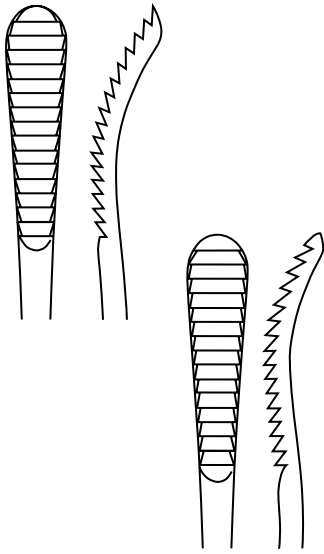

Aufricht Rasp

21.5cm/8.5in

Product No.	Description
200-222	Up Cutting, Curved
200-223	Down Cutting, Curved

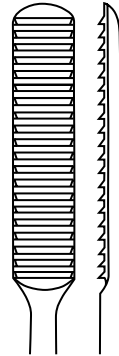

Cottle (Parkes)

21.0cm/8.5in

Product No.	Description
200-224	Down Cutting

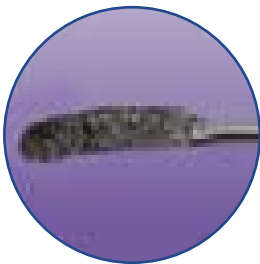

Peet Cottle Rasp

19cm/7.5in

Product No.
200-192



Description
Slightly Curved, Diamond Dust
Finishing Rasp

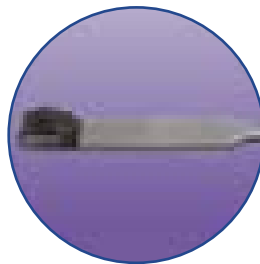

Glabellar Rasp

20.0cm/8.0in

Product No.	Description
200-190	Tungsten Carbide Button Rasp

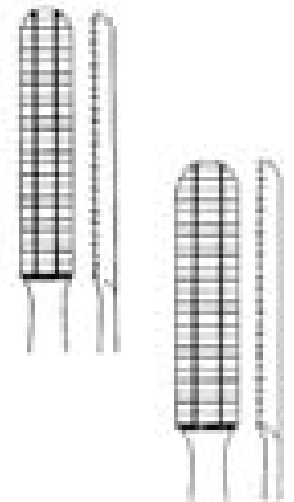

Maltz Rasp

18.0cm/7.0in

Product No.	Description
200-225	Down Cutting
200-226	Up Cutting

EAR, NOSE AND THROAT - *Chisels/Osteotomes*



Neivert Osteotome

Single Guarded
20.0cm/8.0in

Product No.	Description
200-182	Straight
200-183	Curved, Right
200-184	Curved, Left



Ballenger Swivel Knife

19.5cm/7.75in

Product No.	Description	
	<i>Bayonet Style</i>	<i>Straight</i>
190-313	3.0mm	190-317
190-314	4.0mm	190-318
190-315	5.0mm	190-319
190-316	6.0mm	190-3196

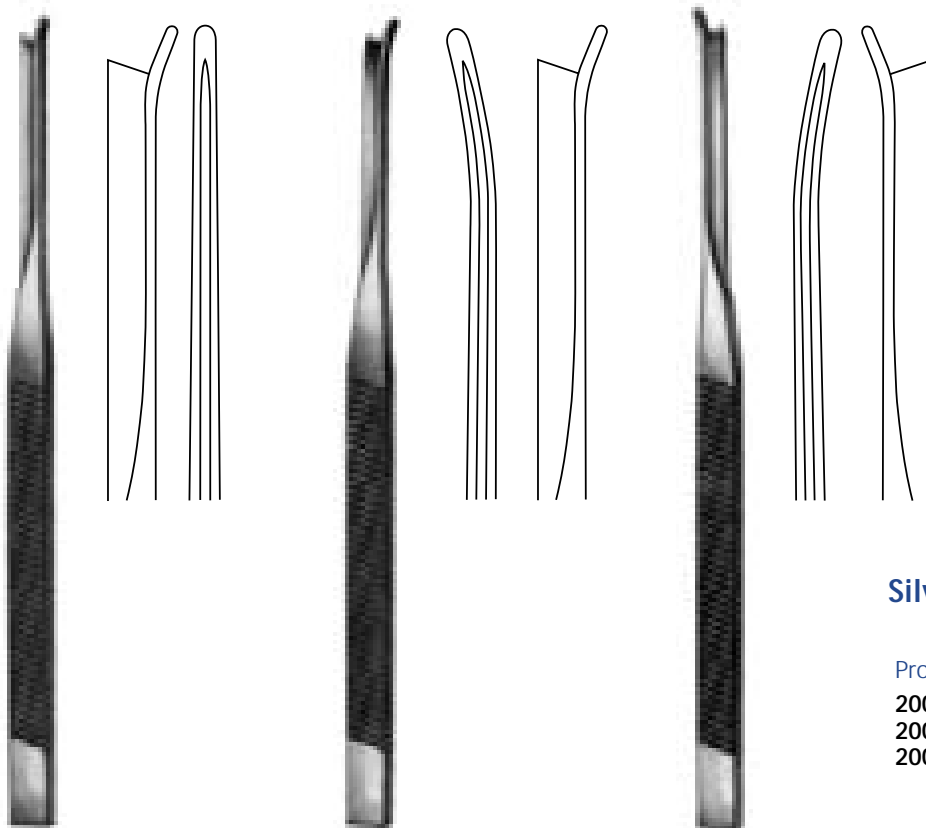

Silver Nasal Osteotome

18.0cm/7.0in

Product No.	Description
200-600	Straight
200-601	Curved, Right
200-602	Curved, Left

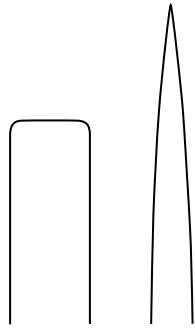
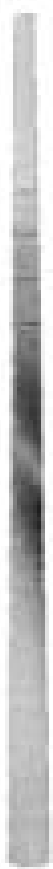

Cottle Osteotome

18.0cm/7.0in

Product No.	Description
200-165	2.0mm
200-166	4.0mm
200-167	6.0mm
200-168	8.0mm
200-169	10.0mm

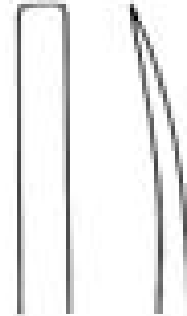

Lambotte Osteotome

17.0cm/6.75in

Product No.	Description
200-148	2.0mm, straight
200-150	3.0mm, straight
200-152	4.0mm, straight
200-154	6.0mm, straight
200-158	2.0mm, curved
200-160	3.0mm, curved
200-162	4.0mm, curved
200-164	6.0mm, curved

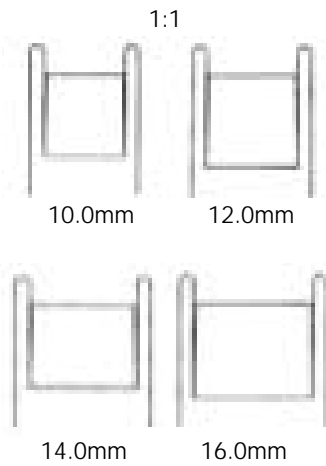
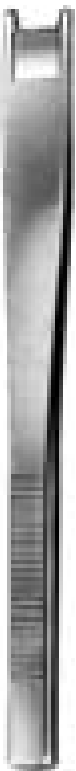

Cinelli Osteotome

Double Guarded
16.0cm/6.25in

Product No.	Description
200-110	10.0mm
200-112	12.0mm
200-114	14.0mm
200-116	16.0mm

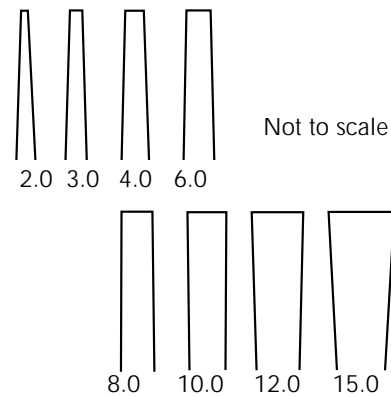
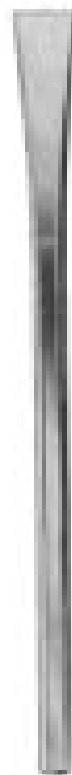

Sheehan Osteotome

16.0cm/6.25in

Product No.	Description
200-122	2.0mm
200-123	3.0mm
200-124	4.0mm
200-126	6.0mm
200-128	8.0mm
200-130	10.0mm
200-132	12.0mm
200-135	15.0mm

EAR, NOSE AND THROAT - *Mallets*



Marina

18.0cm/7.0in

Product No. **201-250**
 Description
 250 grams, 1.0in OD
 Interchangeable Nylon Caps

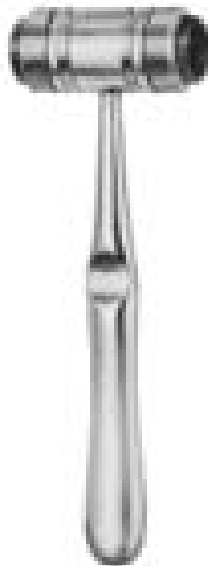

Mead

18.5cm/7.25in

Product No. **201-252**
 Description
 230 grams, Interchangeable
 Plastic Discs

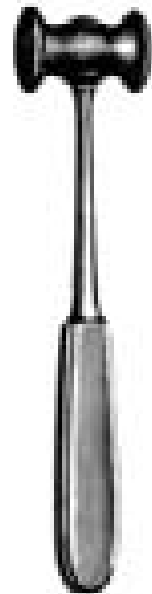

Lucae

18.0cm/7.0in

Product No. **201-254**
 Description
 265 grams, 1.0in O.D.

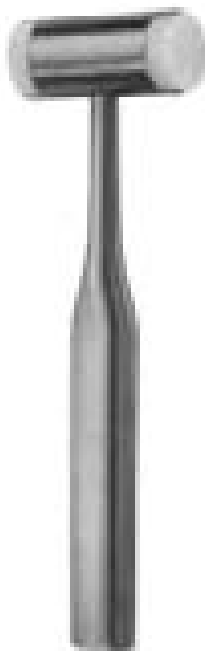

Marina Delicate

18.0cm/7.0in

Product No. **201-251**
 Description
 218 grams, .75in O.D.
 Interchangeable Nylon Caps

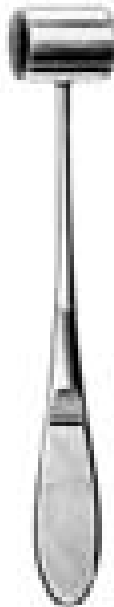

Baby Gerzog

16.5cm/6.5in

Product No. **201-256**
 Description
 172 grams, .75in O.D.

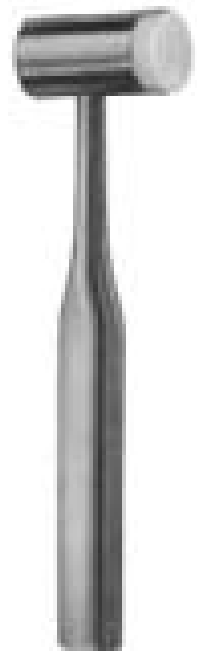

Marina Nylon/Steel

18.0cm/7.0in

Product No. **201-253**
 Description
 265 grams, 1.0in O.D.
 One Face Steel,
 One Face Plastic



Cartilage Crushers, Morselizers & Clamps



Cartilage Crushing Box

Product No.	Description
190-560	Rectangular, smooth bed



Tolsdorf Cartilage Crusher

Product No.	Description
190-562	Round, serrated bed

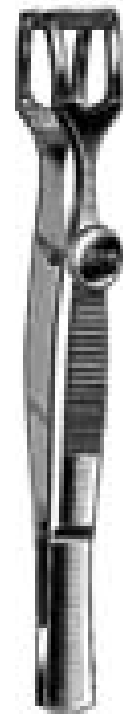

Cottle Columella Clamp

Product No.	Description
190-340	10.0cm/4.0in

Rubin Rhinoplasty Set

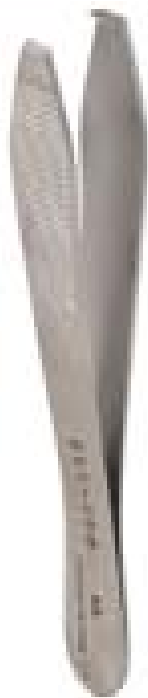

Rubin Rimometer

Product No.	Description
289-258	Alar Crimper, 11.0cm/4.5in



Rubin Alar Morselizer

Tungsten Carbide Jaws

Product No.	Description
289-260	21.0cm/8.25in



Septal Morselizer

Tungsten Carbide Jaws with Guard

Product No.	Description
289-261	21.0cm/8.25in



EAR, NOSE AND THROAT - *Rubin Rhinoplasty Set*

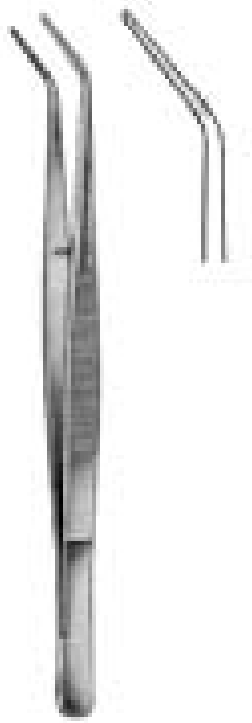

Rubin Strut Forceps

Product No.	Description
289-262	18.0cm/7.0in



Rubin Nasal Frontal Osteotome

Product No.	Description
289-264	U-Shaped - for lateral use near the Glabella



Rubin Nasal Lateral Osteotome

Product No.	Description
289-266	U-Shaped with sharp knife to narrow Dorsal width



Rubin Dorsal Osteotome

18.0cm/7.0in

Product No.	Description
289-246	8.0mm
289-247	10.0mm
289-248	11.0mm
289-250	12.0mm
289-251	14.0mm
289-252	16.0mm

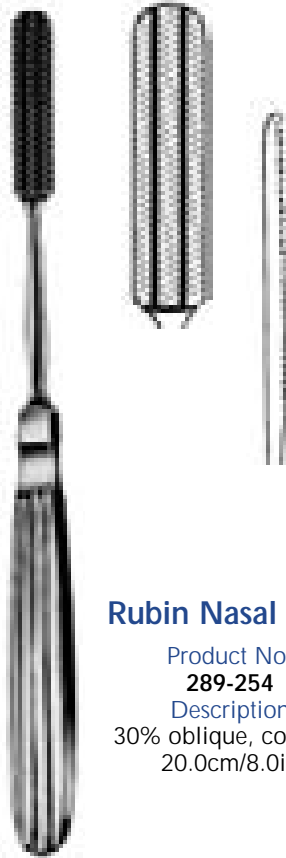

Rubin Nasal Rasp

Product No.	Description
289-254	30% oblique, concave
	20.0cm/8.0in



Rubin Nasal Frontal Rasp

Product No.	Description
289-256	Glabella button rasp
	19.0cm/7.25in

Rongeurs & Bone Cutters



Mini-Friedman

Product No. Description
200-312 12.0cm/5.0in

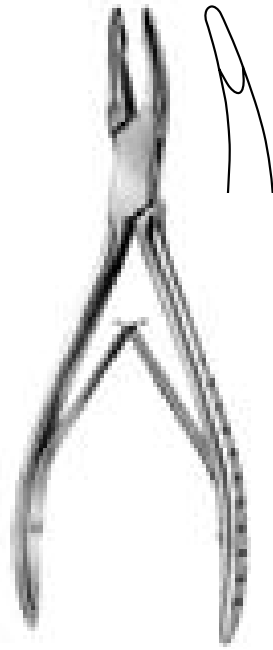

Friedman

Product No. Description
200-314 14.0cm/5.5in

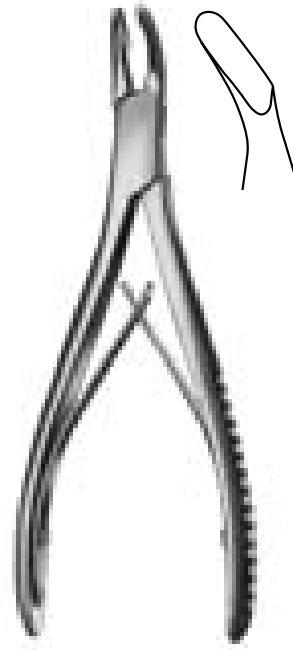

Cleveland

Product No. Description
200-316 14.0cm/5.5in

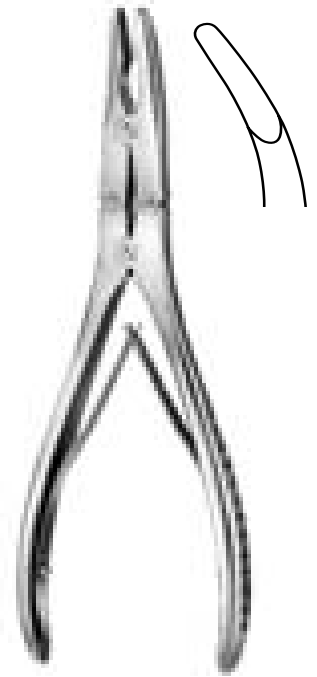

Ruskin

Double Action
 Product No. Description
200-324 Curved, 18.0cm/7.0in



Lempert

Product No. Description
200-310 Straight, 18.0cm/7.0in
200-311 Curved, 18.0cm/7.0in



Beyer
 Double Action

Product No. Description
200-320 Curved, 18.0cm/7.0in

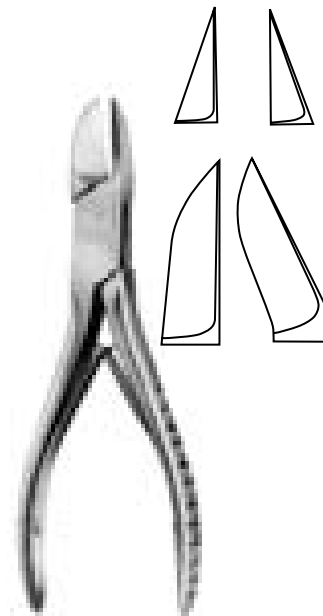

Liston

Product No. Description
200-410 Straight, 14.0cm/5.5in
200-411 Straight, 17.0cm/6.75in
200-420 Curved, 14.0cm/5.5in
200-421 Curved, 17.0cm/6.75in

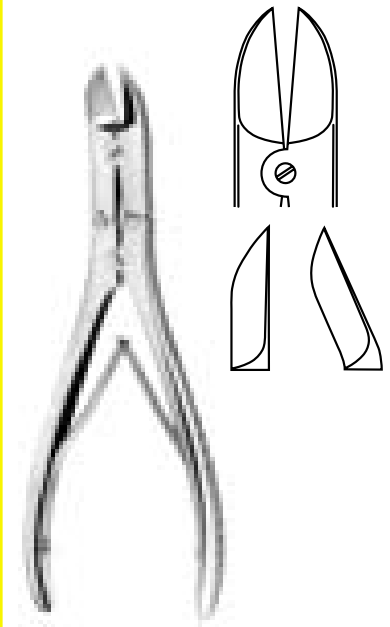

Ruskin-Liston
 Double Action

Product No. Description
200-430 Straight, 15.0cm/6.0in
200-431 Curved, 15.0cm/6.0in
200-440 Straight, 18.0cm/7.25in
200-441 Curved, 18.0cm/7.25in

EAR, NOSE AND THROAT - *Truswell Trocar & Alligator/Cupped Forceps*

Hartmann Alligator Forceps

Product No.	Description
190-324	8.5cm/3.5in, Micro Jaw
190-320	14.0cm/5.5in
190-322	17.0cm/6.75in
190-330	8.5cm/3.5in

- 2.0mm
- 3.0mm

Hartmann Cup Forceps

8.5cm/3.5in

Product No.	Description
190-332	2.0mm Cup
190-333	3.0mm Cup

Noyes Nasal Forceps

Product No.	Description
190-328	1 x 2 Teeth, 14.5cm/5.5in

Truswell Implant Insertion Trocar



Product No.	Description
190-327-1	With Trocar triangle shape: 5.0mm x 95.0mm
190-327-2	With Trocar triangle and conical shape: 5.0mm x 95.0mm

This 5mm Trocar and Sheath has been custom designed to ease the passage of facial implants. The instrument with removable trocar is introduced through a 3.0mm incision at one end of the implant site. The triangulated trocar tunnels to an incision at the exit point of the implant site. A release button allows the removal of the trocar, leaving an empty sheath. An alligator grasper is introduced into the distal end of the sheath. The entire insertion instrument is removed, leaving the grasping forceps in position to accept the implant to be pulled through the newly created tunnel. Created by Dr. William Truswell.

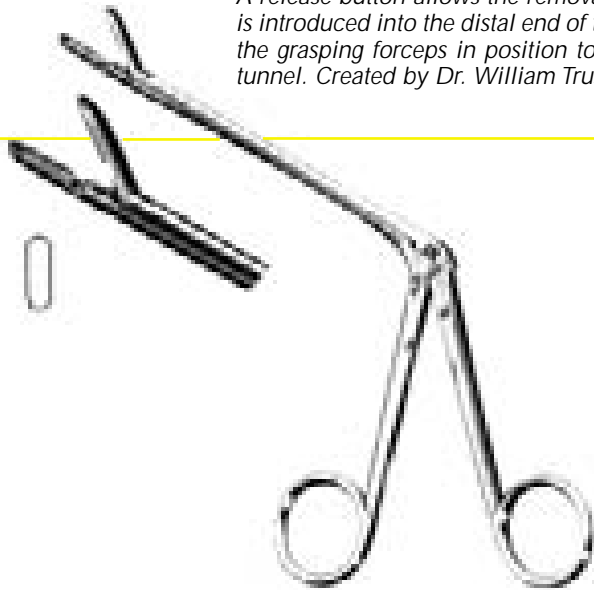

Takahashi

19.0cm/7.5in

Product No.	Description
200-572	4 x 10mm Jaws, Straight



Carroll Tendon

11.0cm/4.5in

Product No.	Description
190-326	Down Curved, used to pull lip prostheses



*D*ERMATOLOGY

Biopsy Punches
Dermal Curettes
Extractors
Nail Nippers
Scalpel Handles

DERMATOLOGY - Biopsy Punches & Bowls

Sterile, Disposable, Biopsy Punch

Seamless, Sharp

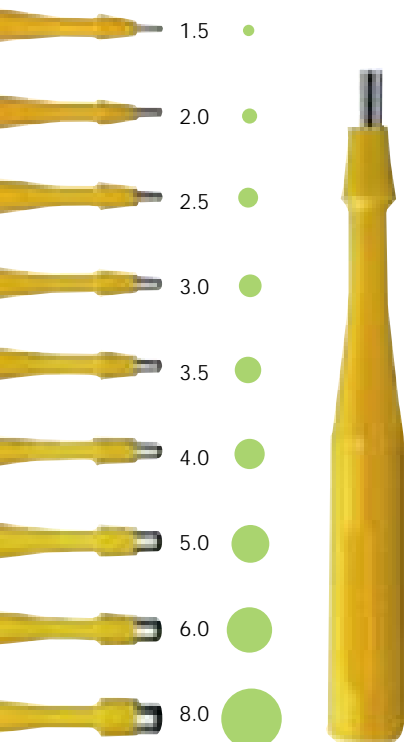

Available in all sizes, box of 25

Product No.	Punch Size
034-015	1.5mm
034-020	2.0mm
034-025	2.5mm
034-030	3.0mm
034-035	3.5mm
034-040	4.0mm
034-050	5.0mm
034-060	6.0mm
034-080	8.0mm

Actual Sizes

Keys Reusable Stainless Steel Biopsy Punch

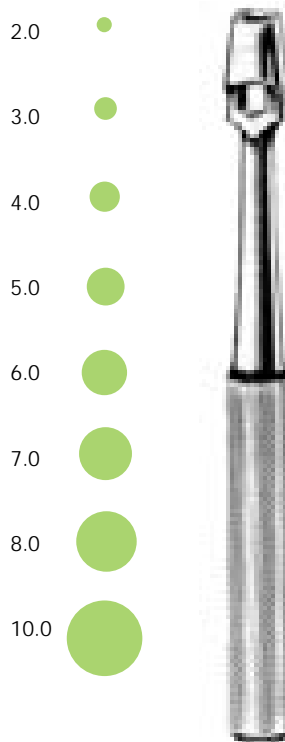

Product No.	Punch Size
033-012	2.0mm
033-013	3.0mm
033-014	4.0mm
033-015	5.0mm
033-016	6.0mm
033-017	7.0mm
033-018	8.0mm
033-020	10.0mm

Actual Sizes

Keys Dermal Biopsy Punch Set

Product No. 033-010B

- 2mm to 8mm Punches
- 2 Handles... Can telescope into each other
- Specimen Retriever
- Aluminum block, well organized
- Totally autoclavable
- Very cost effective

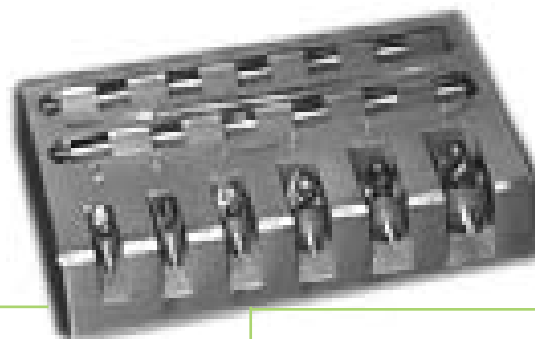

Emesis Basin
Stainless Steel

Product No.	Description
020-060	6.0 x 3.5 x 1.75in
020-061	8.0 x 3.6 x 1.75in
020-065	10.0 x 4.5 x 2.0in



Sponge Bowl
Stainless Steel

Product No.	Description
020-070	5.75 x 2.5in
020-071	4.5 x 2.0in
020-072	6.5 x 3.0in
020-073	7.5 x 3.0in



Iodine Cup
Stainless Steel

Product No.	Description
020-080	6oz
020-081	14oz



Medicine Cup
Stainless Steel

Product No.	Description
020-085	Graduated, 2oz

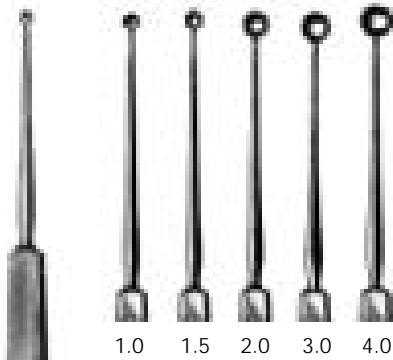

1.0 1.5 2.0 3.0 4.0

Meyhoefer

12.5cm/5.0in, Round, Sharp Edge
Closed Curette

Product No.	Description
190-184	1.0mm
190-185	1.5mm
190-186	2.0mm
190-187	3.0mm
190-188	4.0mm

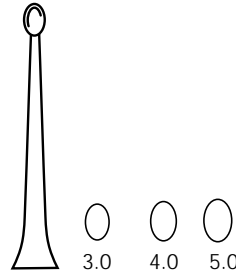

Marina Dermal

16.0cm/6.25in, Sharp
Oval Spoon, Closed

Product No.	Description
190-190	#0 - 3.0mm O.D.
190-191	#1 - 4.0mm O.D.
190-192	#2 - 5.0mm O.D.

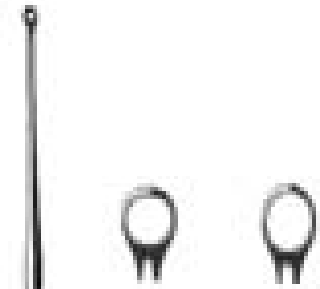
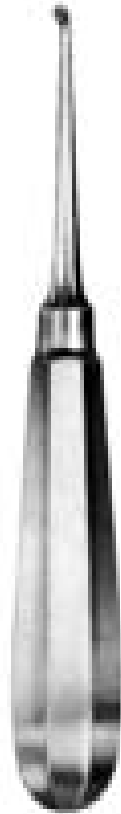

Fox

14.0cm/5.5in
Oval Tip

Product No.	Description
190-201O	1.0mm
190-202O	2.0mm
190-203O	3.0mm
190-204O	4.0mm
190-205O	5.0mm
190-206O	6.0mm

Round Tip

Product No.	Description
190-201R	1.0mm
190-202R	2.0mm
190-203R	3.0mm
190-204R	4.0mm
190-205R	5.0mm
190-206R	6.0mm

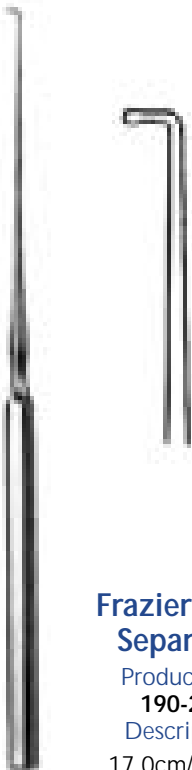

Frazier Dura Separator

Product No.
190-220
Description
17.0cm/6.75in



2.0mm



4.0mm



6.0mm

Single Use Curette Blades

The convenience of a disposable curette with the strength of a reusable curette.

- No need to re-sharpening
- No cleaning required
- Use with any #3 blade handle
- Most popular sizes available

Product No.	Description
C32	2.0mm
C34	4.0mm
C36	6.0mm



10 blades per box

DERMATOLOGY - *Extractors*

COMEDONE EXTRACTORS



Schamberg

Product No.	Description
190-140	Extra fine with Crimp
190-150	Delicate with Crimp
190-151	Medium with Crimp
190-152	Heavy with Crimp
190-154	Delicate w/o Crimp

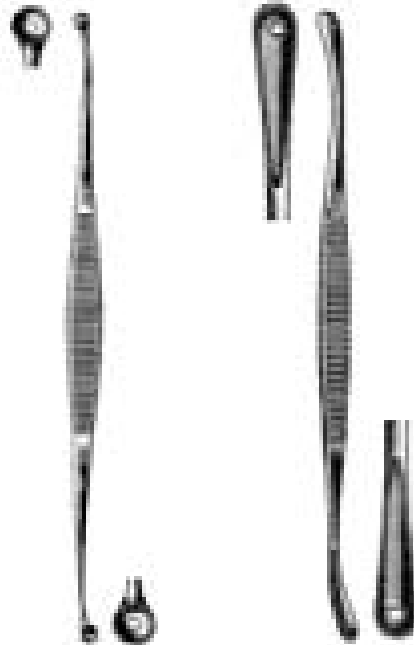

Unna

Product No.	Description
	Double-Ended
190-156	Double-Ended Oval, 14.5cm/5.75in
190-155	Double-Ended Round hole, 12.0cm/4.75in



Saalfield

Product No.	Description
	Round Extractor with Spear
190-158	Spear w/ Oval, 11.0cm/4.25in
190-159	Spear w/ Oval, 14.5cm/5.75in
190-160	Spear w/ Round, 10.0cm/4.0in

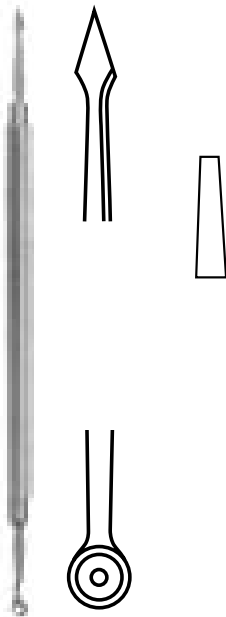

Walton (Katsch)

Round Extractor with Spear
16.0cm/6.25in

Product No.	Description
190-157	Double-Ended with Spear Cap and Round Expressor

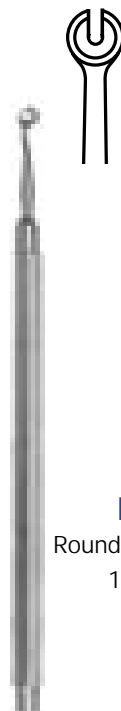

Shalita Expressor

Round extractor with slot
16.0cm/6.25in

Product No.
190-611

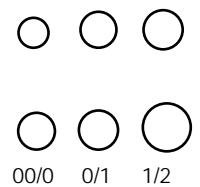
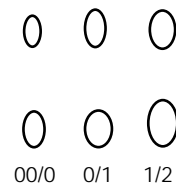

Marina Spoon

13.5cm/5.25in, Double-Ended, Sharp
Oval Tip

Product No.	Description
190-2130	00/0
190-2140	0/1
190-2150	1/2

Round Tip

Product No.	Description
190-213R	00/0
190-214R	0/1
190-215R	1/2

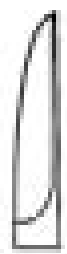

Double Spring
 Long, Narrow, Straight
 Jaws
 Product No.
190-500
 Description
 11.0cm/4.25in
 Product No.
190-501
 Description
 15.0cm/6.0in



Turnbull Barrel Spring
 Curved Jaws
 Product No.
190-502
 Description
 12.0cm/4.75in
 Product No.
190-503
 Description
 14.0cm/5.5in



English Anvil Nail Splitter
 Straight Jaws
 Product No.
190-505
 Description
 13.0cm/5.25in



Heavy Pattern w/ Lock
 Curved Jaws
 Product No.
190-506
 Description
 14.5cm/5.75in

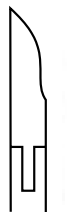

Double Spring
 Straight Jaws
 Product No. Description
190-507 13.0cm/5.0in
 Short, Straight Jaws
 Product No. Description
190-510 10.0cm/4.0in

DERMATOLOGY - Scalpel Handles



040-070



040-080



040-070L



040-070R



040-060



040-070RO



040-090



040-098

#3 Handle Graduated

040-070
For blades #10-18
12.5cm/5.0in

#4 Handle

040-080
For blades #20-25
13.5cm/5.25in

#3 Handle Long

040-070L
For blades #10-18
20.0cm/8.0in

#3 Handle Round

040-070R
For blades #10-18
14.5cm/5.75in

#3 Handle Round, Graduated

040-060
For blades #10-18
14.5cm/5.75in

#3 Handle Round, Oblique

040-070RO
For blades #10-18
14.5cm/5.75in

#7 Handle

040-090
For blades #10-18, 16.0cm/6.25in

Beaver Blade Handle

040-098
12.5cm/5.0in
040-099
15.0cm/6.0in

Sterile, Disposable Safety Scalpels



Blade size #10 **040-110D**



Blade size #11 **040-111D**



Blade size #15 **040-115D**

Pre-assembled stainless steel blades on plastic handles packaged sterile in peel-apart packaging. Available in boxes of 10

Sterile Disposable Scalpel Blades

Sterile, Disposable



#10 Scalpel
040-110
Box of 100



#11 Scalpel
040-111
Box of 100



#15 Scalpel
040-115
Box of 100

Scalpel Blade Removers

The secure and confident way to remove blades



15.0cm/6.0in
Product No.
040-101



5.0cm/2.0in
Product No.
040-100









Cannulas
Tubing
Aspirators
Infusion Pumps
Binders
Facial Supports
Bras

EXPOSITION & GARMENTS

LIPOSUCTION & GARMENTS - *Cannulas & Tubing*

Cannulas

Each cannula is manufactured from the finest quality stainless steel. Each cannula is precisely machined, polished and assembled to your own specifications. Choose from the most popular styles below, or create your own custom cannulas. Each cannula carries a lifetime warranty against defect.

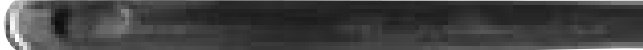
	20-1205-00 3 Port Radial (Mercedes)
	20-1207-00 Triport
	20-1206-00 Pyramid
	20-1201-00 2 Hole Standard
	20-1200-00 1 Hole Standard
	20-1240-00 Cane
	20-1211-00 Cobra K +
	20-1222-00 Spatula





Infusion Cannulas

	20-1218-00 Multi Hole Infusion
	20-1257-00 Open Ended

All infusion tips come with deluxe luer lock tip base.

Micro Cannulas

All Micro Cannulas are mounted on deluxe luer lock hubs to withstand lateral stress. The distal ends of all cannulas have been filled to eliminate dead space. Micro Cannulas are available in a wide range of lengths, diameters and curves.

	20-1515-00 Infiltration
	20-1501-00 Aspiration Harvesting
	20-1503-00 Side Port Re-injection
	20-1504-00 Re-injection Style II
	20-1507-00 V-Dissection

One-Piece Cannula Handles

Choose the appropriate handle to accompany your cannula



Champagne
Ergonomic



1" Aluminum handle

Two-piece Cannula Handles



1" Delrin plastic



**Two-Piece
Cannula Base**
Detaches from handle
7/8" Tip Base

Luer Lock Handles

Delrin Infusion Aspiration handle



Aluminum Luer Lock



On/Off Infusion Handle
Aluminum, with stop-cock



Trumpet Valve
On/Off Infusion valve

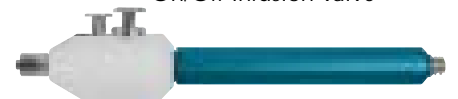

Select from 52 tips styles, 4 tip shapes, 12 standard lengths, 14 standard diameters, 5 basic curve options, 22 handles. Choose vent holes or not, or simply create your own custom cannula. Call your **Marina Medical Account Manager** for further details.

Aspirators, Infusion & Tubing



Hercules™ Aspirator

Product No. 20-5007-00

Three high-powered, dual-cylinder piston pumps make this aspirator the most powerful on the market. Quiet and with a dent and scratch resistant casing. 5-year warranty on parts and labor.



Infusion Pump

Product No. 20-6000-00

Variable flow rate from 0-850 ml/min. System includes:

- 2 Infusion Needles
- 2 aluminum leuc lock handles
- 3 Spinal Needles
- Infusion Tubing (case of 5)
- Pneumatic foot switch
- Custom IV stand



V-Pal Sub Sonic Surgical System

Product No. 40-1001-00

The V-Pal utilizes a vibratory concentric motion that allows surgical instruments to pass effortlessly through soft tissue. Designed to fit the surgeon's hand, V-Pal combines a low vibration motor with a vibratory handpiece. An insulated sleeve is not required since overheating is never a problem. The V-Pal, using an offset mass cannula design, causes the surgical instrument to move in a 3mm concentric motion. This motion is profoundly different than the simple forward/backward motion found in reciprocating systems. This system randomly spreads cannula energy, reducing the battering-ram motion of reciprocating systems.

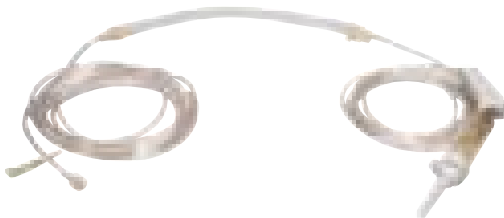

Infiltration Tubing

Product No.	Description
24-6001-00	188" length (Case of 10)

Ready to use. No assembly required.
Single spike with silicon sleeve.



Aspiration Tubing

(Case of 10)

Baxter™

Product No.	Description
24-5103-00	9 ft limp
24-5102-02	12 ft. flex
24-5105-00	14 ft limp

Sorenson™/Quick-Fit™

Product No.	Description
24-5104-00	9 ft limp
24-5102-01	12 ft. flex
24-5106-00	14 ft limp



LIPOSUCTION & GARMENTS - *Garments for Liposuction* PLASTIC AND THORACIC

Hand made from the highest quality fabrics.



Liposuction Sleeve

Hook and eye adjustable closure. Must supply arm measurements for accurate size.

Product No. **GA-502**

Liposuction Slip-on Sleeve

Can be used with style 502.

Product No. **GA503**



Men's One-Piece Body Control

Features non-slip shoulder straps and a snap-crotch fly front. Constructed of nylon and spandex.

Sizes: S, M, L, XL, XXL

Product No. **GA302**



Men's Vest

Features adjustable Velcro® shoulder straps and front zipper closing. Made of soft cotton Lycra® spandex material.

An E. Marie Design.

Sizes: S, M, L, XL, XXL

Product No. **GA959**

Where applicable, add S for Small, M for Medium, L for Large, XL for Extra Large, and XXL for Double-Extra Large

Facial Support Binders



Otoplasty Band

Ear and face support. Men's and Ladies.
One size fits all.

Product No. **GA007**



Chin and Neck Support

Seamless. Men's and Ladies.
Sizes: M; L.

Product No. **GA203M**
GA203L



Chin and Neck Band

Soft nylon Lycra® spandex material.
Men's and Ladies.

Product No. **GA202**



Breast Binder

Ladies "Touch & Stay". Continuous adjustable (22" to 44") control. Strong Velcro® adjustment. Width is 3". Made of strong elastic material. One adjustable size.

Product No. **GA1750**



Men's or Ladies' Touch-and-Stay® Binder

Features continuous adjustable (22" to 44" or 30" to 50") control. Please specify waist size at time of ordering. Strong Velcro® adjustment.

Sizes: 6", 9", 12" width.

Product No.

GA802SM

GA802ML

Description

S/M (22" - 44")

M/L (30" - 50")

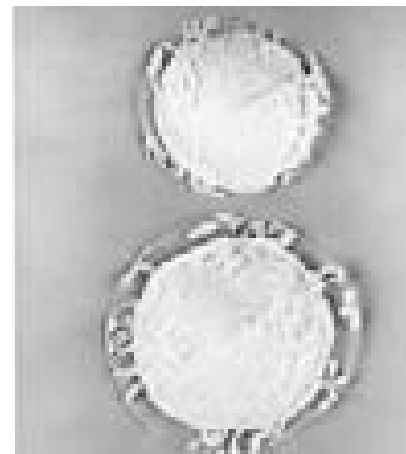

Breast Enhancers

A hidden beauty product by EMS Surgical, used by many post-mastectomy breast reconstruction patients. Patented. Specify Cup sizes: A, B, C, D.

Product No. **GATTO**

Compression Garments



3" regular waist



6" high waist

Girdles

Hook and eye, with zipper closure. Available with 3" regular waist or 6" high waist. Above knee or below knee. Available in white, black, or beige.

Sizes: S, M, L, XL.

Product No. **GA92W**

Product No. **GA92HW**



Men's Brief

High wadded. Zipper front opening.

Sizes: S, M, L, XL.

Product No. **GAH21**



Men's or Women's To the Knee Girdle

Hook and eye, adjustable.

Sizes: S, M, L, XL.

Product No. **GA90KG**

Add S for Small, M for Medium, L for Large, XL for Extra Large

LIPOSUCTION & GARMENTS - *Surgical Bras*



Style #9 Bra

Built-up, strain-free shoulder straps. Cotton/spandex with double-lined front. Front closure.

34-38" ABC cup; 40-46" BCD cup.

Product No. **GA9**



Style #958 - E-Z-On™

Lace trim, adjustable Velcro® shoulder straps. Cotton and Lycra® spandex with front zipper closing. Also available with Velcro® front closure or hook and eye front. Cup available.

S: 32-34"; M: 34-36"; L: 38-40"; XL: 40-42"; Queen: 44"; Super: 48-50"

Product No. **GA958**

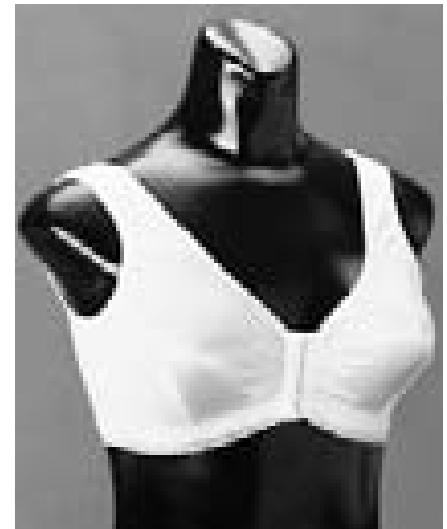

Style #1524 Bra

Features built-up, strain-free shoulder straps. Constructed of nylon and Lycra® spandex. Hook and eye front closing. One cup size only.

Sizes: 34-46"

Product No. **GA1524**



D-Bra

Easy to install. Can be used as a wrap and straps slip up after recovery. Latex free. Velcro® front. White only.

S; M; L; XL.

Product No. **GADBra**



New D-Bra

Easy to install, 88% nylon, 12% Spandex. Available in white or black.

Sizes: 32/34, 36/38, 40/42

Product No. **GAD2**



L-Bra

Slimmer version of our #958. Adjustable shoulder straps. Available with hook and eye closure. Cotton/Lycra®. White only.

S: 32-34"; M: 34-36"; L: 38-40"; XL: 40-42"; Queen: 44"; Super: 48-50"

Product No. **GALBra**

Where applicable, add S for Small, M for Medium, L for Large, XL for Extra Large, and XXL for Double-Extra Large

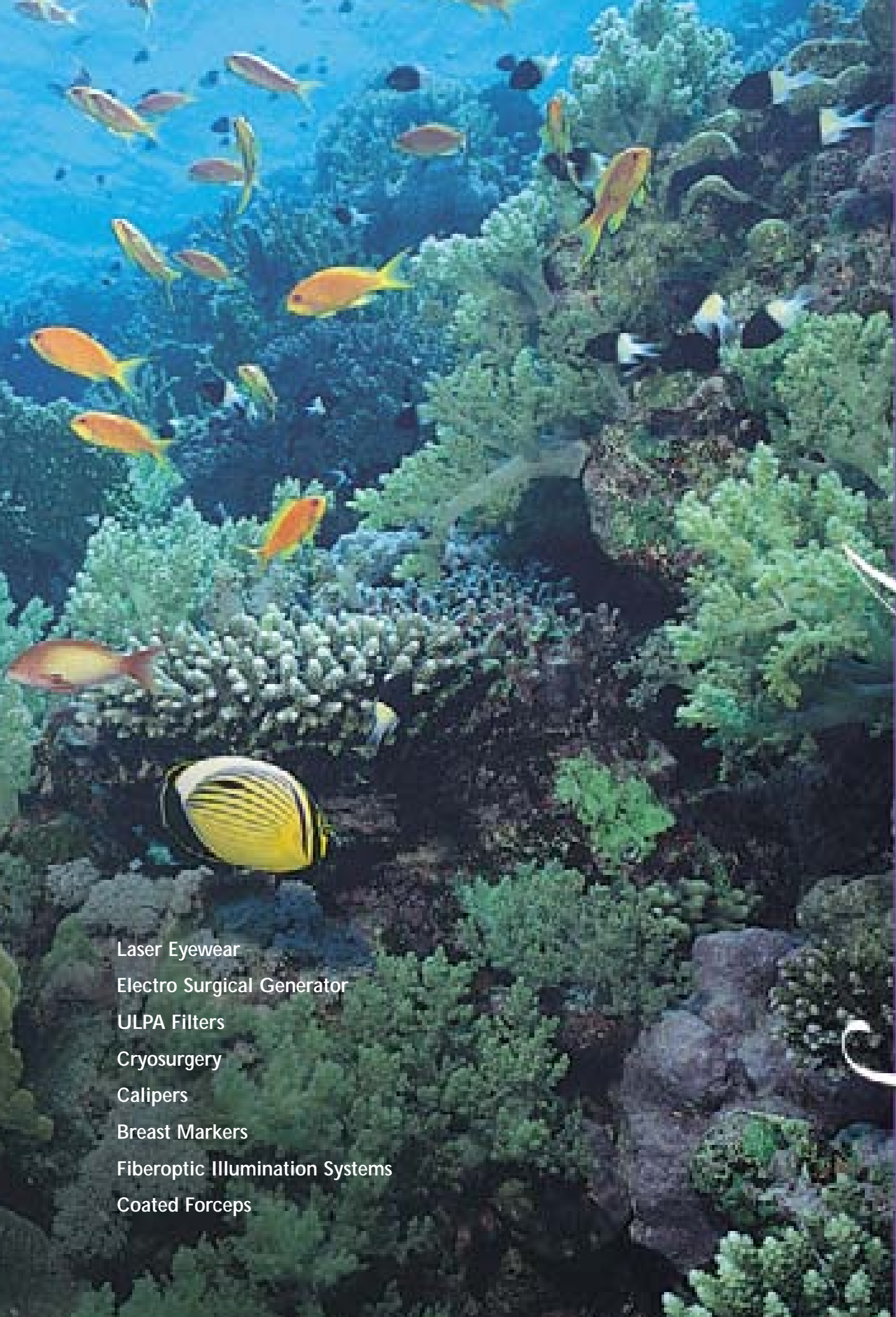

- Laser Eyewear
- Electro Surgical Generator
- ULPA Filters
- Cryosurgery
- Calipers
- Breast Markers
- Fiberoptic Illumination Systems
- Coated Forceps

SURGICAL ACCESSORIES

SURGICAL ACCESSORIES - *Calipers*

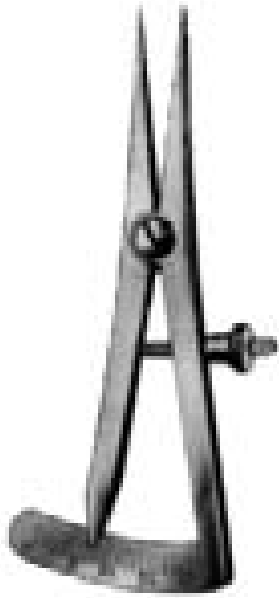

Castroviejo

Graduated 0-20mm

Product No.	Description
190-546	8.5cm/3.25in



Jameson

Graduated in Inches/mm

Product No.	Description
190-548	9.5cm/3.75in

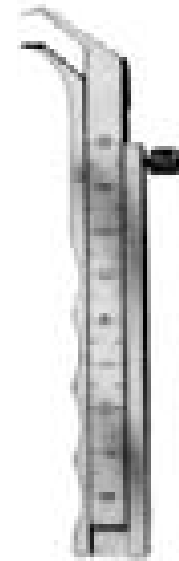

Thorpe

Graduated in mm

Product No.	Description
190-550	9.5cm/3.75in



Surgical Ruler

Dual Scale in Inches/mm

Product No.	Description
270-420	15.0cm/6.0in, stainless steel
270-422	20.0cm/8.0in, stainless steel

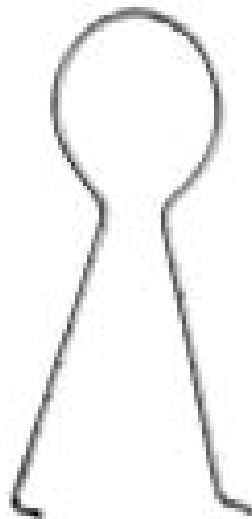

McKissock Breast Caliper

Product No.	Description
201-138	38.0mm
201-142	42.0mm
201-145	45.0mm



Halpern Breast Caliper

Product No.	Description
201-168	38.0mm diameter
201-164	34.0mm diameter

Markers



Barron Areola Marker

Product No.
201-036
Description
Four diameter sizes:
40.0mm, 44.0mm, 48.0mm, 52.0mm



Freeman Areola Marker

Product No.	Description
201-038	38.0mm
201-039	38/42mm
201-042	42.0mm
201-045	45.0mm

Suture Needles



Slightly Curved

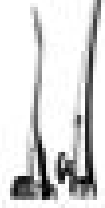

Curved

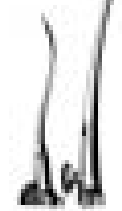

D'Assumpcao Flap Marker

Product No.	Description
110-397	16.0cm/6.25in

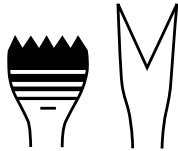

Pitanguy Flap Demarcator

Product No.	Description
110-398	Small, 15.0cm/6.0in
110-399	Large, 25.5cm/10.0in

Suture Passing Needle (Reverdin)

Product No.	Description
200-020	Slightly Curved, 15.0cm
200-022	Slightly Curved, 21.0cm
200-024	Curved, 15.0cm
200-026	Curved, 21.0cm



SURGICAL ACCESSORIES - Ocular Shields (for external placement)



FOR NON-LASER APPLICATIONS

- Autoclavable plastic shields
- 1mm thick well-polished edges
- Opaque black or transparent yellow
- Includes suction cup

Product No.	Description
OK23-201	X-Small: 21.5mm
OK23-202	Small: 25.0mm
OK23-204	Medium: 27.0mm
OK23-206	Large: 28.0mm

Add B for black, Y for yellow

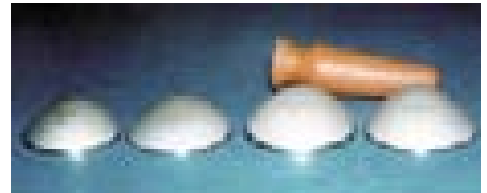

- Autoclavable metal shields
- Designed to conform to the globe with a vault over the cornea, the posterior surface and the rounded edges are highly polished, to assure patient's comfort and safety
- With no bulky or heavy handle, each shield includes a suction cup for easy insertion and removal

Product No.	Description
OK21-261	X-Small: 22.0 x 19.5mm
OK21-262	Small: 24.0 x 21.0mm
OK21-264	Medium: 25.5 x 22.0mm
OK21-266	Large: 26.5 x 23.0mm
OK21-268	X-Large: 28.5 x 26.0mm



Ocular Shield with Handles

Product No.	Description
OK23-201H	X-Small: 21.5mm
OK23-202H	Small: 25.0mm
OK23-204H	Medium: 27.0mm

Available in yellow or black

FOR NON-LASER APPLICATIONS



Non-Laser Disposable Eye Shields

Product No. G31-7300

- For non-laser use only
- Easy peel adhesive
- Latex free and hypoallergenic
- Allows access to bridge, brow and temples

Pack of 100

FOR LASER APPLICATIONS



Disposable Laser Eye Shields

Product No. G31-8300

- Laser-safe for medical lasers with wavelengths between 190-11,000nm
- Protection level: (OD>7@190-11,000nm)
- Latex free and hypoallergenic

Pack of 50



Add L for left, R for right

Laser Eye Care Shields

Product No.	Description
OK21-262H	Small: 24.0 x 21.0mm
OK21-264H	Med: 25.5 x 22.0mm
OK21-266H	Large: 26.5 x 23.0mm

- Vaulted at cornea, marked with size and safety ring at edge
- Offset handle facilitates insertion and removal
- Handle is near lower lid to allow closure without upper lid pressing on handle



SpectraShield™

- Made of opaque lightweight alloy
- Protects against all popular lasers
- Adjustable nose piece and safety strap
- CR certified against direct laser radiation

Product No.	Description
G31-7308	Black with 4 piece replacement frames
G31-7313	White with 4 piece replacement frames
G31-7311	Replacement frames (12 pc.)

Laser Eyewear



LightSpeed™ Technology

The adaptation of Liquid Crystal technology from the aerospace and computer world for use in safety eyewear. LightSpeed™ technology allows users to work safer and more efficiently in Intense Pulse Light (IPL) environments.



Product No.	Description
G31-90900	LightSpeed Electronic, OTE eyewear. Responds to IPL light in less than a millisecond

Cooling Eye and Face Masques



Face Liner

- Maintains Masque's cool temperature and protects the face
- Allows patient to wear the Masque for hours at a time
- Is washable and reusable

Product No.	Description
OK29-113	Liner for Face Masque (pack of 6)

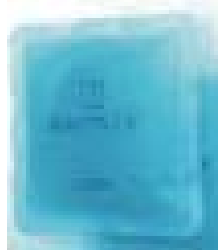

Cooling Squares

- Important adjunct during Botox and collagen injections, chemical peels, laser hair removal, tattoos and other laser procedures

Product No.	Description
OK29-112	Cooling Squares (pack of 4)

- Important facts:**
- Hypoallergenic and non-toxic
 - Cooling relieves pain and swelling by reducing inflammatory response in blood vessels and limiting blood flow to affected areas

"Clinical tests verify 72 hours of continuous cooling after surgery promotes patient's rapid healing and comfort" — Dr. Tina S. Alster, Founder of Washington Institute of Dermatologic Laser Surgery

Eye and Face Masques



- Stays colder longer than comparable products
- Remains flexible at freezing temperatures
- Distributes coolant evenly
- Velcro straps hold the masque comfortably on the face permitting unrestricted activity

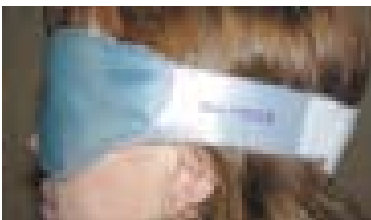

Product No.	Description
OK29-114	Eye Masque

Product No.	Description
OK29-111	Face Masque

Coated Durette® II External Shields

Treated posterior surface of the shields diffuse whatever light penetrates through the skin for greater comfort.

TREATED INSIDE TO DIFFUSE LIGHT



Product No.	Description
OK22-345	Coated Durette® II external laser shields. Includes 1 pair external shields, 2 elastic headbands and a plastic sterilization tray.

The OPSOFT Mouthguard

- For protection during hair removal and cutaneous treatment with laser, IPL, IPL/RF or RF systems
- Eliminates pain from the laser fluence (and other energy) of the teeth, gums and buccal mucosa
- Better than dental rolls
- Soft rubbery polymer easily conforms to the buccal area
- May be used over dental braces, repair and implants

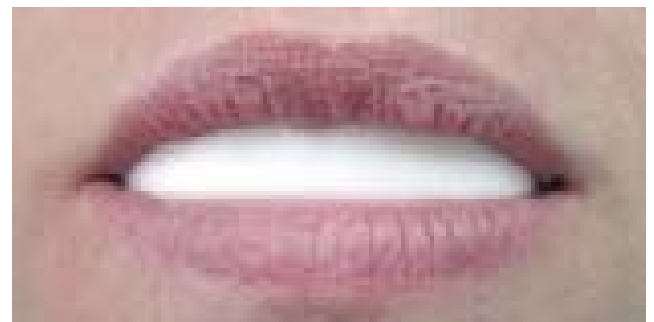
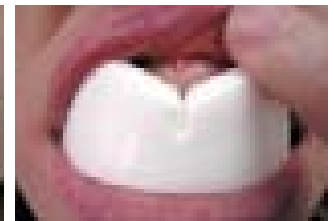

Product No.	Description
OK60-104	Single use. 10 per pack



SURGICAL ACCESSORIES

Smoke Evacuation



ESU

MODEL 2001e ElectroSurgical Unit

- 120 watts maximum power output
- Five output modes
- Digital diagnostic error codes
- Hand Control with Optional Foot Control
- One-year warranty

Product No.	Description
300-300A	110V, includes disposable hand-control pencil, patient pad and manual
300-300B	220V

Specifications:

Maximum power output by operating mode:

Pure Cut = 120 watts	Blend = 90 watts
Coagulation = 80 watts	Fulguration = 40 watts
	Bi-Polar = 30 watts



PURE-VAC™ Smoke Evacuation System



"Cart mountable". Includes footswitch. Strong, quiet unit with "single use" filter. Excellent for use when cross contamination may be a problem.

Product No. 300-349

Hand Control ElectroPencil



Product No.	Description
300-510	ElectroPencil for hand or foot control to be used with ESU unit
300-516	Reusable, 3 Prong Fitting
300-515	Sterile, disposable, 3 Prong Fitting, box of 20



SURGIFRESH™ Mini Turbo

110V-120V/50&60HZ
Includes Footswitch

Product No.	Description
300-350	110V-120V
300-351	220V

Wheel Kit Assembly

Product No. 300-352

Reusable Electrodes - Cutaneous Surgery

Standard 3/32" diameter shaft. Working length: 2-2 1/2". One per pack. Improved full shaft insulation. Tapered shaft fits easily in any handpiece.



Product No.
P900-6424
Description
Blade



Product No. Description
P900-6403 Small Ball
P900-6404 Large Ball



Product No. Description
P900-6408 Straight Needle, broad
P900-6405 Fine Needle, short
P900-6411 Adjustable Needle
P900-6410 Broad Needle, short
P900-6409 Broad Needle, long



K30-8012 4 1/2" Tungsten, insulated, Angled Tip 45°



K30-8013 6 5/8" Tungsten, insulated, Straight



K30-8015 4" Tungsten, insulated, Curved



K30-8016 5 7/8" Tungsten, insulated, Curved



K30-8017 4 7/8" Tungsten, insulated, Angled Tip 45°

Micro Dissection Needles



K30-8000 1 1/4" Tungsten, insulated, Straight



K30-8006 1 5/8" Tungsten, insulated, Straight



K30-8007 1 5/8" Tungsten, insulated, Angled Tip 45°



K30-8008 2" Tungsten, insulated, Straight



K30-8009 2" Tungsten, insulated, Angled Tip 45°

ULPA Filters, Tubing & Accessories



ULPA-Smoke™

Product No. 305-833
Description Non-sterile

ULPA filter with activated Carbon.
For use with Surgifresh™ system
(3 to a case)



ULPA-YAG™

Product No. 300-821
Description Non-sterile

VLSI Grade 2 ULPA filter with odor control activated Carbon for use with Erbium: YAG Laser System.
For Surgifresh™ unit.
(1 per case)

Please contact your Marina Medical Account Manager for a complete list of all your ESU and Smoke Evacuation Accessories



For use with all PURE-VAC™ Smoke Evacuation Systems

ULPA-Clear™

Product No. 300-822
Description Non-sterile

VLSI Grade 2 ULPA **1 HOUR** disposable filter with odor control activated Carbon.



Disposable Pre-Filter

7/8in (22.0mm) port

Product No. 300-837

Description

6in O.D., case of 10



Tubing Connector (Reducers)

Description **Product No.**

3/8in to 1 1/3in 300-838

7/8in to 1 1/3in 300-839

Box of 3



Footswitch

For Surgifresh™

Product No. 300-823

For PURE-VAC™

Product No. 300-824



Corrugated Tubing

Smoke filtration tubing sets
Case of 3
306-843

Case of 10
306-844

Arm Stand Assistant

Velcro straps for holding suction tubing

Product No. 300-825



SURGICAL ACCESSORIES - Cryosurgery



P-100-6065



P-100-6060

Nitrospray Plus

- Improved seal eliminates O-ring positioning
- Easy to use, comfortable to hold
- Grooved head, curved trigger
- Three year warranty

Static holding time: 8-12 hours. Intermittent use: 3-6 hours of patient treatment time.

Product No.	Description
P100-6060	16oz fill capacity. Includes 5 spray tips, tip protector and base holder
P100-6065	10oz fill capacity. Includes 5 spray tips, tip protector and base holder
P100-6066	Pressure seal ring

Spray Tips

Reusable and safe



Product No.	Description
P100-6516	16 gauge, purple
P100-6517	17 gauge, white
P100-6518	18 gauge, gray
P100-6519	19 gauge, brown
P100-6520	20 gauge, yellow
P100-6525	Spray tips, set of 5

Miscellaneous Accessories



Product No.	Description
P100-6527	Spray Tip Protector
P100-6530	Bent Spray Extension
P100-6700	Needle Extender, rigid
P100-6521	Brymill Accessory Adapter

Cutaneous Probes

Reusable vent tube provided with each probe.

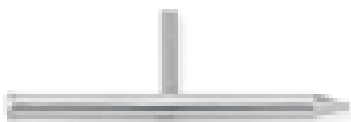

Product No. P100-6602
Description: Cutaneous Probe, 2mm

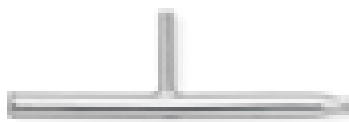

Product No. P100-6604
Description: Cutaneous Probe, 4mm

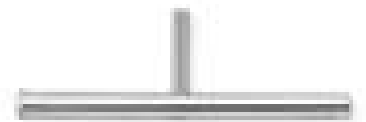

Product No. P100-6606
Description: Cutaneous Probe, 6mm

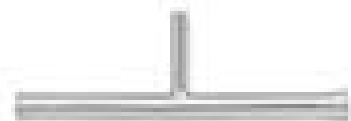

Product No. P100-6608
Description: Cutaneous Probe, 8mm

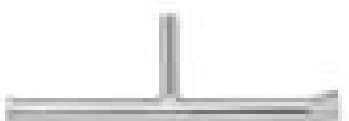

Product No. P100-6610
Description: Cutaneous Probe, 10mm

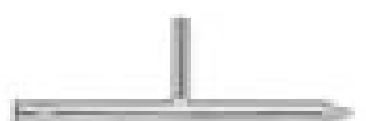

Product No. P100-6620
Description: Cutaneous Probe, Sharp

One-Step Hair Restoration System

The One-Step Hair Restoration System is applicable to situations where there is thinning hair. There are four sizes of hair transplanters available ranging from 0.8mm diameter which is suitable for single hair graft, reconstruction eyebrows, eyelashes, beards, and the pubic region. The 1.0mm diameter is suitable for transplanting 1 - 2 hairs. The 1.3mm diameter is suitable for transplanting a bundle of 3 - 4 hairs. And the 1.5mm is suitable for transplanting a bundle of 5 - 6 hairs.

For Doctors:

- Easy to use: One-Step Hair Restoration System, no need to make holes separately
- Insure totally natural-looking hair transplants
- Time for a complete restoration is short
- Minimal bleeding
- Local anesthetic

For Patients:

- Provides a superior, undetectable natural result
- There is a fast healing time
- No additional maintenance required
- No bandage or dressing is required
- Minimal or no scarring

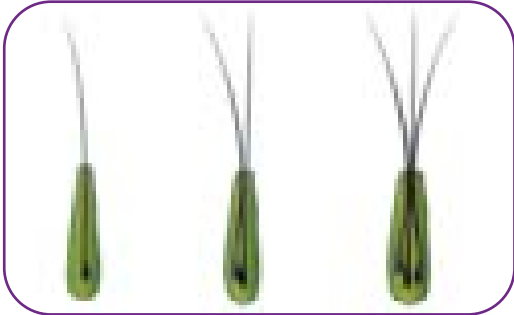

Hairgrafts (single or bundle hair).



A single hair graft being placed on the needle with smooth forceps.



The HANS hair transplanter in place.



Sold as a kit or each needle sold separately

Product No.	Description
33-HN08	Replaceable needle for 33-HT08
33-HN10	Replaceable needle for 33-HT10
33-HN13	Replaceable needle for 33-HT13
33-HN15	Replaceable needle for 33-HT15
33-HT08	Hans Hair Transplanter 0.8mm (each)
33-HT10	Hans Hair Transplanter 1.0mm (each)
33-HT13	Hans Hair Transplanter 1.3mm (each)
33-HT15	Hans Hair Transplanter 1.5mm (each)
33-HT101	Cutting Board
33-HT408	Blade Holder

Free Instructional CD upon request.
Product No. 33-HTV



SURGICAL ACCESSORIES - Sterilization & Infection Control



Manual Kwiklave (M/MK)

Product No.	Description
T1730M/MK	2 gallon, 6.7" x 13.4" chamber
T2340M/MK	5 gallon, 9.0" x 18.5" chamber
T2540M/MK	6 gallon, 10.0" x 18.7" chamber
T3870M	22gallon, 15.1" x 29.9" chamber

MK Series reduces sterilization time by 50%

- Auto shut off
- Overheat cutoff
- Double safety lock
- Dual safety thermostats



Automatic Kwiklave (EA/EKA)

Product No.	Description
2340EA/EKA	5 gallon, 9.0" x 18.5" chamber
2540EA/EKA	6 gallon, 10.0" x 18.7" chamber
3870EA	22 gallon, 15.1" x 29.9" chamber

EKA Series reduces sterilization time by 50%

- Auto shut off
- Overheat cutoff
- Fills, sterilizes, exhausts and dries at the touch of a button
- Closed-door active drying system
- Pre-loaded cycles
- Dual safety thermostats



Valueklave 1730

Product No.	T1730
Description	7" chamber

- Fast cycle time. 9 minutes from a hot start (standard unwrapped cycle time)
- Automatic shut off at the end of both the sterilization and dry cycles
- Double safety lock
- Overheat cutoff
- Dual safety thermostats
- One year warranty on parts and labor
- Speed and quality you demand with the value you deserve



Chamber Brite Autoclave Cleaner

- Cleans and descales chamber, reservoir, and copper tubing of most steam autoclaves
- Pre-measured packs
- No pre-mixing required
- Odor free
- 10 Single Use package

Product No. **TCB0010**



Brite Shield Static Soak & Ultrasonic Cleaner

Product No. **P901-1100**
Description
800gm container

- Ideal for removing bio-burden from hand instruments
- Polishes and protects with unique passivation process to restrict rust and corrosion

Sterilization Containers



Polyvinyl Containers



Autoclavable with silicone mat

Product No.	Description
300-201	11.0 x 7.0 x 1.0in
300-202	11.0 x 7.0 x 1.75in

**Other sizes available.
Please contact your Marina
Medical Account Manager.**



Autoclavable with silicone mat

Product No.	Description
300-200	7.0 x 3.0 x 1.0in

Aluminum Containers



Product No.	Description
R642.07	Container, perforated lid / bottom 500 x 155 x 75mm



Product No.	Description
R310.10	Container, perforated lid, unperforated bottom 280 x 280 x 100mm, gray
R311.10	Container, perforated lid, perforated bottom 280 x 280 x 100mm, gray
R310.10B	Basket for container size 280 x 280 x 100mm

Instrument Identification Tape



Tape in rolls

Product No.	Description	
151-001	White	
151-002	Blue	
151-003	Kelly Green	
151-004	Red	
151-005	Yellow	
151-006	Purple	
151-007	Orange	
151-009	Black	

SURGICAL ACCESSORIES - *Fiberoptic Illumination Systems*

Marina Medical offers a complete line of headlight components to enable you to get the perfect headlight system for your needs. Choose the headlight, headband and fiberoptic cable style you prefer. Headlight fiberoptic cables have an ACMI™ light source end-fitting, but are available to fit other brands. Each headlight has a unique design to allow for a complete range of motion from side to side and up and down.

For Variable Bifurcated, add **VB** to the product number.
 For Variable, Single, add **V** to the product number.
 For Fixed Bifurcated, add **FB** to the product number.
 For Fixed Single, add **F** to the product number.

All headlight systems include:

- Headlight module
- Headband
- Fiberoptic cable (single or bifurcated)
- 2 garment clips
- Duffel bag



Deluxe Plus Headband

- Ratchet style crown and rear tension adjustment
- Replaceable Breath-O-Prene comfort liners to wipe away sweat from front and back

Product No. 5-DHCK5000

Deluxe Headband

- Clip style crown tension adjustment
- Ratchet style rear tension adjustment
- Replaceable Breath-O-Prene comfort liners

Product No. 5-DHC5000



Standard Headband

- Economical design with plastic matte finish
- Clip style crown tension adjustment
- Ratchet style rear tension adjustment
- Replaceable leather-like comfort liner

Product No. 5-HLC5000



Ultra Comfort Headband

- Flexible design
- Breath-O-Prene fabric with unique "open construction" provides maximum breathability
- Fully washable to minimize skin irritation and moisture problems
- Ultra light weight for comfort

Product No. 5-UHC5000

Instrumentation Sets

Plastic Surgery Sets

050-304	Iris Scissors - Straight, Standard: 11.5cm/4.5in
050-305	Iris Scissors - Straight, Serrated: 11.5cm/4.5in
050-180	Metzenbaum Dissecting Scissors - Curved: 14.5cm/5.75in
050-426	Ragnell Flat Tip Scissors, Curved, 12.0cm/4.75in
400-932	Kaye Rhytidectomy Scissors, Curved, TC Blades : 15.0cm/6.0in
060-126	Adson Forceps with Tying Platform, No Teeth, Standard Tip, Serrated, 12.0cm/4.75in
060-137	Adson Tissue Forceps - Straight, 1x2 Teeth, Serrated Tying Platform: 12.0cm/4.75in
060-170	Adson-Brown Tissue Forceps - Straight, 9x9 Teeth: 12.0cm/4.75in
070-002	Halsted Mosquito Forceps - Straight, Standard: 13.0cm/5.25in
070-004	Halsted Mosquito Forceps - Curved, Standard: 13.0cm/5.25in
070-504	Backhaus Towel Clip: 9.0cm/3.5in
070-506	Backhaus Towel Clip: 13.5cm/5.25in
080-060	Webster Needle Holder - Serrated Jaws: 13.0cm/5.0in
080-100	Crilewood Needle Holder - Serrated Jaws: 15.0cm/6.0in
110-076	Senn Retractor - Blunt: 16.0cm/6.25in
110-122	U.S. Army Retractor - Set of Two: 21.5cm/8.5in
110-321	Volkman 4 Prong Retractor, Blunt : 21.5cm/8.5in
160-115	Allis Forceps - 4x5 Teeth: 15.0cm/6.0in
190-639	Frazier Suction Tube, 9fr
190-180	Joseph Skin Hook, Single Prong, 15.0cm/6.0in
190-182	Joseph Skin Hook, Double Prong, 5.0mm width, 15cm/6.0in

Blepharoplasty Sets

050-402	Stevens Tenotomy Scissors - Blunt/Blunt, Curved: 12.5cm/5.0in
060-411	Iris Tissue Forceps, 1/2 Curved, 1 x 2 Teeth, 10.0cm/4.0in
440-319	Blepharoplasty Forceps. Diamond Insert, Delicate Hooks on Adson Forceps
440-321	Blepharoplasty Forceps. TC Inserts , Standard Hooks on Adson Forceps with Platform
440-323	Blepharoplasty Forceps. Extra Fine Hooks on Castroviejo Forceps
400-927	Blepharo Scissors - Curved, Flat Narrow Tip, Serrated TC Blades: 13.5cm/5.25in
420-075	Halsey Needle Holder - Straight, Serrated Jaws, TC Inserts: 13.0cm/5.0in
070-005	Halsted Micro Mosquito Forceps - Curved, Delicate: 13.0cm/5.25in
070-504	Backhaus Towel Clip: 9.0cm/3.5in
110-050C	Desmarres Lid Retractor - 10.0mm, Insulated: 14.0cm/5.5in
110-054C	Desmarres Lid Retractor - 14.0mm, Insulated: 14.0cm/5.5in
110-046C	Jaeger Lid Plate - Non-Conductive Coated Stainless Steel: 11.0cm/4.25in
190-168	Frazier Dura Hook - Blunt: 12.5cm/5.0in
190-546	Castroviejo Caliper
060-420	Green Fixation Forceps, without Lock : 10.0mm wide, 10.0cm/4in

Suture Sets

040-070	Scalpel Handle #3 - for Blade sizes # 10-18: 13.0cm/5.0in, Graduated in Cms
050-425	Ragnell Flat Tip Scissors, Straight, 12.0cm/4.75in
050-016SC	Operating Scissors - Straight, Blunt/Sharp, Supercut: 14.5cm/5.75in
060-117	Adson Dressing Forceps - Straight, Fine: 12.0cm/4.75in
060-134	Adson Tissue Forceps - Straight, 1 x 2 Teeth, Fine: 12.0cm/4.75in
070-002	Halsted Mosquito Forceps - Straight, Standard: 13.0cm/5.25in
070-004	Halsted Mosquito Forceps - Curved, Standard: 13.0cm/5.25in, Quantity 2
070-036	Kelly Hemostatic Forceps - Straight: 14.0cm/5.5in
070-038	Kelly Hemostatic Forceps - Curved: 14.0cm/5.5in
070-504	Backhaus Towel Clip: 9.0cm/3.5in, Quantity 2
420-100	Crilewood Needle Holder - Straight, TC Inserts:15.0cm/6.0in

Mohs Surgery Sets

040-070	Scalpel Handle #3 - for Blade sizes #10-18: 13.0cm/5.0in, Graduated in Cms
040-101	Scalpel Blade Remover: 15.0cm/6.0in
050-012	Operating Scissors - Straight, Blunt/Sharp: 11.5cm/4.5in
050-702SC	Iris Scissors - Curved, Supercut: 11.0cm/4.25in
060-136	Adson Tissue Forceps - Straight, 1 x 2 Teeth, Smooth platform: 12.0cm/4.75in
070-002	Halsted Mosquito Forceps - Straight, Standard: 13.0cm/5.25in
070-005	Halsted Micro Mosquito Forceps - Curved, Delicate: 13.0cm/5.25in
070-504	Backhaus Towel Clip: 9.0cm/3.5in
173-825	Bishop-Harmon Forceps - 1 x 2 .5mm Teeth: 9.0cm/3.5in
190-173	Lahey Single Skin Hook, 12.0cm/4.75in
190-202O	Fox Dermal Curette, 2.0mm Tip
420-060	Webster Needle Holder - Straight, Serrated Jaws, TC Inserts: 13.0cm/5.0in
420-090	Baumgartner Needle Holder - Straight, Serrated Jaws, TC Inserts: 14.0cm/5.5in

INDEX

A

Accessories.....	75
Adson Forceps.....	26-27
Adson-Brown Forceps.....	26
Agris-Dingman Transauxillary Breast Dissector.....	41
Alar Morselizer.....	59
Alligator/Cupped Forceps.....	62
Allis Clamps.....	31
Alm Skin Retractor.....	45
Aluminum Containers.....	85
Anderson Retractor.....	48
Areola Markers.....	77
Arm Stand Assistant.....	81
Aspirators, Infusion & Tubing.....	71
Aufricht Nasal Rasp.....	55
Aufricht Nasal Retractor.....	42
Autoclave.....	84
Autoclavable Cleaner.....	84

B

Baby Gerzog Mallet.....	58
Baby Lexer.....	15
Baby Webster Needle Holder.....	36
Backhaus Towel Clip.....	33
Ballenger Swivel Knife.....	56
Barraquer (Kurth) Forceps.....	30
Barraquer Micro Needle Holder.....	38
Barron Areola Marker.....	77
Barsky Skin Hook.....	46
Beyer Rongeur.....	61
Biggs Mammoplasty Retractor.....	40
Billeau Ear Loops.....	52
Breast Binders.....	73
Biopsy Punches.....	64
Bi-Polar Forceps.....	28
Bishop-Harmon Suture Forceps.....	29
Blepharoplasty Forceps.....	29
Blepharoplasty Scissors.....	17
Bow Retractors.....	45
Bowls.....	64
Breast Retractors & Dissectors.....	40-41
Brite Shield.....	84
Buck Ear Curettes.....	52

C

Calipers.....	76
Camera (Endo).....	10
Cannulas & Tubing.....	70
Cannula Bases.....	70
Cannula Handles.....	70
Carmalt Splinter Forceps.....	30
Carroll Tendon Cupped Forceps.....	62
Cartilage Crushers.....	59
Cartilage Crushing Box.....	59
Castroviejo Caliper.....	76
Castroviejo Micro Scissors.....	24
Castroviejo Needle Holder.....	38
Castroviejo Suturing Forceps.....	29
Chamber Brite.....	84
Chisels/Osteotomes.....	56-57
Cinelli Osteotome.....	57
Closed Ring Gradle Scissors.....	17
Cleveland Rongeur.....	61
Comedone Extractors.....	66
Compression Garments.....	73

Containers, Sterilization.....	85
Converse Alar Retractor.....	50
Converse Nasal Retractors.....	50
Converse Scissors.....	21
Cottle Osteotome.....	57
Cottle Columella Clamp.....	59
Cottle Nasal Speculum.....	50
Cottle (Parkes) Rasp.....	55
Cottle Periosteal Elevator.....	51
Cottle Septum Elevator.....	51
Coronal Brow Lift Retractor.....	48
Cottle Dorsal Angled Shanks Scissors.....	20
Cottle-Neivert Retractor/Needle Guide.....	47
Cottle Thumb Hook.....	47
Crile-Rankin Hemostatic Clamp.....	32
Crilewood Needle Holder.....	36
Cryosurgery.....	82
Curettes.....	52
Curette Blades (Disposable).....	65
Cushing Specialty Forceps.....	31
Cushing Bayonet Forceps.....	31
Cutaneous Probes.....	82
Cutaneous Surgery.....	80

D

D'Assumpcao Flap Marker.....	77
Davis Scissors.....	22
Deaver Retractor.....	43
DeBakey Tissue Forceps.....	27
Dermal Curettes.....	65
Dermatology.....	63-68
Desmarres Chalazion Clamp.....	34
Desmarres Lid Retractor.....	44
Derf Needle Holder.....	36
Di Breast Clamp.....	34
Dingman Otobradars.....	53
Dissecting Scissors.....	14-15
Dorsal Osteotome (Rubin).....	60
Double-Ended Desmarres Retractor.....	44
Double-Ended Disposable Ear Curettes.....	52
Double-Ended Breast Retractor.....	40
Double Prong Thimble Hook.....	47
Double Spring Nail Nippers.....	67
Dressing & Tissue Forceps.....	26-27

E

Ear Curettes, Double-Ended, Disposable.....	52
Ear Loops, Billeau.....	52
Ear, Nose & Throat.....	49-62
Electrodes, Reusable.....	80
Electrosurgical Unit.....	80
Endoscopic.....	4-10
Endoscopic Dissectors.....	6-7
Endoscopic Endobrow.....	5
Endoscopic Equipment.....	10
Endoscopic Retractors.....	8-9
Endoplastic Graspers & Scissors.....	5
Endoscopic Sheaths.....	4
English Anvil Nail Splitter.....	67
Electrosurgical Unit (ESU).....	80
Extractors.....	66
Eye Shields.....	78

F

Feilchenfeld Splinter Forceps.....	30
Ferriera Style Retractor.....	8-9
Fiberoptic Cord (Autoclavable).....	9
Fiberoptic Illumination Systems.....	86
Foerster Sponge Forceps.....	34
Fomon Lower Lateral Alar Scissors.....	20
Fomon Dorsal Angled Shanks Scissors.....	20
Fomon Nasal Rasps.....	54
Fomon Skin Hooks.....	46
Footswitch.....	81
Forceps & Clamps.....	25-34
Fox Curettes.....	65
Frazier Dura Separator.....	65
Frazier Skin Hook.....	46
Freer Elevators.....	51
Freeman Areola Marker.....	77
Freeman Flap Retractor (Lighted).....	43
Freeman Rake Retractor.....	48
Friedman Rongeur.....	61

G

Garments for Liposuction.....	72
General Series (Scissors).....	12
Gelpi Retractor.....	45
Gillies Needle Holder.....	37
Glabellar Rasp.....	55
Glass Bead Mirror Warmer.....	53
Goldman-Fox Scissors.....	18
Gorney Rake Spring Neck Retractor.....	48
Gorney Scissors.....	22
Gradle Scissors (Open & Closed).....	17
Graefe (Iris) Skin Hook.....	46
Green Fixation Forceps.....	29
Griffith Brown Forceps.....	29
Guthrie Skin Hook.....	46

H

Halpern Breast Caliper.....	76
Hair Restoration.....	83
Hair Restoration Forceps.....	28
Halsey Needle Holder.....	36
Halsted Mosquito (Adson) Forceps.....	32
Halsted Mosquito Forceps.....	33
Hand Control ElectroPencil.....	80
Hartmann Alligator.....	62
Hartmann Cup Forceps.....	62
Hartmann Mosquito Forceps.....	33
Heaney/Simon Retractor.....	43
Heavy Pattern Nail Nippers w/ Lock.....	67
Heiss Retractor.....	45
Hemostatic Clamps.....	32
Hemostatic Forceps.....	33
Hercules™ Aspirator.....	71

I

Infiltration Tubing.....	71
Infusion Cannulas.....	70
Infusion Pump.....	71
Instrument Identification Tape.....	85
Instruments for Forehead & Facelift Endoscopy.....	4
Instrumentation Sets.....	87-88
Iris (Graefe) Forceps.....	27

J				
Jaeger Lid Plate Retractor	44	Mixer Hemostatic Clamp	32	
Jameson Caliper	76	Monitors (Endo)	10	
Jansen Bayonet Forceps	31	Myomectomy Scissors	17	
Jeweler Forceps	28	N		
Joseph Elevator	51	Nail Nippers	67	
Joseph Skin Hook	47	Nasal Frontal Osteotome (Rubin)	60	
Joseph Nasal Rasp	54	Nasal Lateral Osteotome (Rubin)	60	
Jones Towel Clip	33	Nasal Rasps	54-55, 60	
Joseph Scissors	21	Nasal Scissors	20-21	
Joseph-Peck Scissors	21	Nasal Series Specialty Retractors	50	
K			Needle Holders	35-38
Kasden Double-Ended Retractor	44	Neivert Needle Holder	37	
Kaye Scissors	22	Neivert Osteotome	56	
Kelly Scissors	16	Nitrospray Plus	82	
Kelly-Rankin Hemostatic Clamp	32	O		
Keyes Dermal Biopsy Punch Set	64	O'Brien Stitch Removal Scissors	19	
Killian Nasal Speculum	50	Olsen-Hegar Needleholders w/Scissors	38	
Kleinert-Kutz Skin Hook	47	Eye Shields	79	
L			Open Ring Gradle Scissors	17
LaGrange (S-curved shanks) Scissors	16	Open Ring Iris Scissors	13	
Lahey Skin Hook	46	Operating Scissors	12	
Lambotte Osteotome	57	P		
Laryngeal Mirrors with Handle	53	Parkes Nasal Elevator	51	
Laser Eyewear	78-79	Suture Passing Needle	77	
Lempert Rongeur	61	Peet Cottle Rasp	55	
Lewis (Joseph) Nasal Rasp	54	Periosteal Elevators	51	
Lighted Freeman Flap Retractor	43	Phlebectomy Hook Set	47	
Light Sources	10	Pitanguy Flap Demarcator	77	
Liposuction	70	Potts-Smith Forceps	27	
Liposuction & Garments	69-74	R		
Lister Bandage Removal Scissors	19	Ragnell-Davis Retractor	44	
Liston Bone Cutter	61	Ragnell (Kilner) Scissors	15	
Littauer Cilia Forceps	30	Rake Retractors	48	
Littauer Stitch Removal Scissors	19	Rees Scissors	22	
Littler Scissors	16	Retractors	42-43	
Lorna (Edna) Towel Clip	33	Retractors & Skin Hooks	39-48	
Lucae Mallets	58	Reverdin Needle	77	
Lucae Specialty Forceps	31	Reynolds Tenotomy Scissors	18	
M			Reynolds Transauxillary Breast Dissector	41
MacCollum-Dingman Transauxillary		Rhytidectomy Scissors	22-23	
Breast Dissector	41	Ribbon Retractors	42	
Maliniac Nasal Retractors	50	Rimometer, Rubin	59	
Mallets	58	Rochester-Oschner (Kocher) Clamp	32	
Maltz Rasp	55	Rochester-Pean Hemostatic Clamp	32	
Marina Dermal Curettes	65	Rollet (Knapp) Retractor	46	
Marina Spoon Extractor	66	Rongeurs & Bone Cutters	61	
Markers, Breast	77	Rubin Rhinoplasty Set	59-60	
Mayo-Hegar Needle Holder	37	Ruler, Surgical	76	
Mayo Scissors	14	Ruskin-Liston Bone Cutter	61	
Mayo Noble Scissors	14	Ruskin Rongeur	61	
McKenty Elevator	51	S		
Mead Mallet	58	Saalfeld Extractors	66	
Metzenbaum Scissors	14	Self-Retaining Skin Retractors	45	
Meyhoefer Curettes	65	Semken Forceps	26	
Micro Cannulas	70	Senn-Mueller Retractor	44	
Micro Dissection Needles	80	Septal Morselizer	59	
Micro Forceps	29	Scalpel Handles	68	
Micro Hook Scissors	5	Scalpels	68	
Micro Metzenbaum Scissors	5	Scalpel Blade Remover	68	
Micro Needle Holders	38	Schamberg Extractors	66	
Micro-Ryder Needle Holder	37	Scissors	11-23	
Micro Scissors	24	Shalita Expressor Extractor	66	
Millard Double Thumb Hook	47	Sheehan Osteotome	57	
Mini-Friedman Rongeur	61	Silver Nasal Osteotome	56	
Mirrors & Accessories	53	T		
McKissock Breast Caliper	76	Takahashi Cupped Forceps	62	
N			Taylor Bayonet Forceps	31
O			Taylor Forceps	31
P			Tebbetts Style Retractor	8
Q			Telescope for Plastic Endoscopy	4
R			Tenotomy Scissors Series	18
S			Thorpe Caliper	76
T			Tissue Wound Retractors	45
U			Tolsdorf Cartilage Crusher	59
V			Towel Forceps	33-34
W			Truswell Trocar	62
X			Tubingen Tying Forceps	29
Y			Turnbull Barrel Spring Nail Nippers	67
Z			Tyrell (Iris) Skin Hook	46
AA			U	
AB			ULPA Filters, Tubing & Accessories	81
AC			Unna Comedone Extractors	66
AD			U.S. Army (Parker-Langenbeck) Retractor	42
AE			V	
AF			V-Pal Sub Sonic Surgical System	71
AG			Vascular (Delicate) Needle Holder	37
AH			Vannas Micro Scissors	24
AI			Vienna Nasal Speculum	50
AJ			Virtus Splinter Forceps	30
AK			W	
AL			Walton (Katsch) Extractor	66
AM			Webster Needle Holder	36
AN			Weitlaner Retractor	45
AO			Westcott Stitch Micro Scissors	24
AP			Westcott Utility Micro Scissors	24
AQ			Wheel Kit Assembly	80
AR			Wieder Tongue Depressor	42
AS			Wilde Specialty Forceps	31
AT			Williger Elevator	51
AU			Wilmer (Converse) Angled on Flat Scissor	21
AV			Wire Cutting Scissors	16
AW			Y	
AX			Yancoskie Abdominoplasty Retractor	48





2761 N. 29th Avenue
Hollywood, FL 33020 USA

Tel: (954) 924-4418
Toll-Free: (800) 697-1119
Fax: (954) 924-4419
Toll-Free Fax: (800) 748-2089
www.marinamedical.com

PRESORTED STANDARD U.S. POSTAGE PAID FT. LAUD., FL PERMIT NO. 5158
